



# USER MANUAL

TELESTO-I

AMB9625 / 2607021191000

VERSION 2.5

JUNE 29, 2023

**WÜRTH ELEKTRONIK** MORE THAN YOU EXPECT

\*\*\*\*\*

## **MUST READ**

### **Check for firmware updates**

Before using the product make sure you use the most recent firmware version, data sheet and user manual. This is especially important for Wireless Connectivity products that were not purchased directly from Würth Elektronik eiSos. A firmware update on these respective products may be required.

We strongly recommend to include in the customer system design, the possibility for a firmware update of the product.

## Revision history

Manual version	FW version	HW version	Notes	Date
1.0	3.4.7	2.0	<ul style="list-style-type: none"> <li>Initial version</li> </ul>	June 2017
2.0	3.4.7	2.0	<ul style="list-style-type: none"> <li>New corporate design and structure</li> </ul>	November 2018
2.1	3.5.0	2.0	<ul style="list-style-type: none"> <li>Added information on new firmware in chapter <code>Firmware history</code></li> <li>Added chapter <code>Reference design</code></li> <li>Added chapter <code>Information for explosion protection</code></li> </ul>	February 2019
2.2	3.5.0	2.0	<ul style="list-style-type: none"> <li>Updated label in chapter <code>General labeling information</code></li> <li>Updated address of Division <code>Wireless Connectivity &amp; Sensors</code> location</li> </ul>	October 2019
2.3	3.5.0	2.0	<ul style="list-style-type: none"> <li>Updated the firmware update chapter.</li> </ul>	June 2020

2.4	3.5.0	2.0	<ul style="list-style-type: none"><li>• Removed 2607021191001 and 2607021191009 from Ordering information as there are no longer pre-cuts or non T&amp;R packages available. The modules are available in all quantities as cut tape.</li><li>• New corporate design.</li></ul>	May 2023
2.5	3.5.0	2.0	<ul style="list-style-type: none"><li>• Added certificates in addition to the required compliance statements in chapter Regulatory compliance information.</li></ul>	June 2023

## Abbreviations

Abbreviation	Name	Description
ACK	Acknowledgement	Acknowledgement pattern confirming the reception of the transmitted data packet.
CS	Checksum	
DC	Duty cycle	Transmission time in relation of one hour. 1% means, channel is occupied for 36 seconds per hour.
FSE	Field Sales Engineer	Support and sales contact person responsible for limited sales area
0xhh [HEX]	Hexadecimal	All numbers beginning with 0x are stated as hexadecimal numbers. All other numbers are decimal.
HIGH	High signal level	
LOW	Low signal level	
LPM	Low power mode	Operation mode for reduced power consumption.
LRM	Long range mode	Tx mode increasing the RX sensitivity by using spreading and forward error correction
LSB	Least significant bit	
MSB	Most significant bit	
PL	Payload	The real, non-redundant information in a frame/packet.
RF	Radio frequency	Describes everything relating to the wireless transmission.
UART		Universal Asynchronous Receiver Transmitter allows communicating with the module of a specific interface.
US	UserSettings	Any relation to a specific entry in the UserSettings is marked in a special font and can be found in the respective chapter.
VDD	Supply voltage	
Payload		The real, non-redundant information in a frame/packet
User settings		Any relation to a specific entry in the user settings is marked in a special font and can be found in the respective chapter
UART		Universal Asynchronous Receiver Transmitter, allows to communicate with the module of a specific interface.
Duty cycle		Transmission time in relation of one hour 1% means, channel is occupied for 36 seconds per hour.

Hexadecimal [HEX] 0xhh		All numbers beginning with 0x are stated as hexadecimal numbers. All other numbers are decimal.
------------------------------	--	---

# Contents

<b>Overview of helpful application notes</b>	<b>11</b>
<b>1. Introduction</b>	<b>12</b>
1.1. Operational description . . . . .	12
1.2. Block diagram . . . . .	12
1.3. Ordering information . . . . .	13
<b>2. Electrical specifications</b>	<b>14</b>
2.1. Recommended operating conditions . . . . .	14
2.2. Absolute maximum ratings . . . . .	14
2.3. Power consumption . . . . .	14
2.3.1. Static . . . . .	15
2.4. Radio characteristics . . . . .	15
2.5. Pin characteristics . . . . .	15
2.6. Integrated flash characteristics . . . . .	16
<b>3. Pinout</b>	<b>17</b>
<b>4. Quickstart</b>	<b>19</b>
4.1. Minimal pin configuration . . . . .	19
4.2. Power up . . . . .	19
4.3. Quickstart example . . . . .	20
<b>5. Functional description</b>	<b>23</b>
5.1. Operating modes . . . . .	23
5.1.1. Switching from transparent to command mode . . . . .	23
5.1.2. Switching from command to transparent mode . . . . .	23
5.1.3. Transparent mode . . . . .	24
5.1.4. /RTS signal, module busy . . . . .	24
5.1.5. Command mode . . . . .	25
5.2. Adopting parameters to fit your application . . . . .	25
5.3. Device addressing and wireless monitoring . . . . .	25
<b>6. Host connection</b>	<b>26</b>
6.1. Serial interface: UART . . . . .	26
<b>7. The command interface</b>	<b>27</b>
7.1. Overview . . . . .	27
7.2. Message overview . . . . .	28
7.3. Data transfer & reception in the command mode . . . . .	30
7.3.1. CMD_DATA_REQ . . . . .	30
7.3.1.1. Example 1: . . . . .	30
7.3.2. CMD_DATAEX_REQ . . . . .	31
7.3.2.1. Example 1: . . . . .	31
7.3.3. CMD_DATAEX_IND . . . . .	32
7.3.3.1. Example 1: . . . . .	32
7.3.4. CMD_DATARETRY_REQ . . . . .	33

7.3.5.	CMD_REPEAT_IND . . . . .	33
7.4.	Requesting parameters and actions . . . . .	35
7.4.1.	CMD_FWRELEASE_REQ . . . . .	35
7.4.1.1.	Example 1: . . . . .	35
7.4.2.	CMD_SERIALNO_REQ . . . . .	35
7.4.3.	CMD_RESET_REQ . . . . .	36
7.4.4.	CMD_RSSI_REQ . . . . .	36
7.4.4.1.	Example 1: . . . . .	37
7.4.5.	CMD_ERRORFLAGS_REQ . . . . .	37
7.5.	Modification of volatile parameters . . . . .	39
7.5.1.	CMD_SET_MODE_REQ . . . . .	39
7.5.2.	Example 1: . . . . .	39
7.5.3.	CMD_SET_PAPOWER_REQ . . . . .	40
7.5.3.1.	Example 1: . . . . .	40
7.5.4.	CMD_SET_CHANNEL_REQ . . . . .	40
7.5.4.1.	Example 1: . . . . .	41
7.5.5.	CMD_SET_DESTNETID_REQ . . . . .	41
7.5.6.	CMD_SET_DESTADDR_REQ . . . . .	42
7.6.	Modification of non-volatile parameters . . . . .	43
7.6.1.	CMD_SET_REQ . . . . .	43
7.6.1.1.	Example 1: . . . . .	44
7.6.1.2.	Example 2: . . . . .	44
7.6.2.	CMD_GET_REQ . . . . .	45
7.6.2.1.	Example 1: . . . . .	45
7.6.3.	CMD_FACTORY_RESET_REQ . . . . .	46
<b>8.</b>	<b>UserSettings - Module configuration values</b>	<b>47</b>
8.1.	Difference between volatile and non-volatile settings . . . . .	47
8.2.	Modifying the UserSettings . . . . .	47
8.3.	UART_PktMode . . . . .	49
8.3.1.	Example 1: . . . . .	49
8.3.2.	Example 2: . . . . .	50
8.4.	UART_PktSize . . . . .	51
8.4.1.	Example 1: . . . . .	51
8.4.2.	Example 2: . . . . .	51
8.5.	UART_RTSLimit . . . . .	52
8.5.1.	Example 1: . . . . .	52
8.5.2.	Example 2: . . . . .	52
8.6.	UART_ETXChar . . . . .	53
8.6.1.	Example 1: . . . . .	53
8.6.2.	Example 2: . . . . .	53
8.7.	UART_Timeout . . . . .	54
8.7.1.	Example 1: . . . . .	54
8.7.2.	Example 2: . . . . .	54
8.8.	UART_DIDelay . . . . .	55
8.8.1.	Example 1: . . . . .	55
8.8.2.	Example 2: . . . . .	55



8.9.	MAC_NumRetrys . . . . .	56
	8.9.1. Example 1: . . . . .	56
	8.9.2. Example 2: . . . . .	56
8.10.	MAC_AddrMode . . . . .	57
	8.10.1. Example 1: . . . . .	57
	8.10.2. Example 2: . . . . .	58
8.11.	MAC_NumRetrysCCA . . . . .	59
	8.11.1. Example 1: . . . . .	59
	8.11.2. Example 2: . . . . .	59
8.12.	MAC_CCARetryDelay . . . . .	60
	8.12.1. Example 1: . . . . .	60
	8.12.2. Example 2: . . . . .	60
8.13.	MAC_DefaultDestNetID . . . . .	61
	8.13.1. Example 1: . . . . .	61
	8.13.2. Example 2: . . . . .	61
8.14.	MAC_DefaultDestAddrLSB . . . . .	62
	8.14.1. Example 1: . . . . .	62
	8.14.2. Example 2: . . . . .	62
8.15.	MAC_DefaultSourceNetID . . . . .	63
	8.15.1. Example 1: . . . . .	63
	8.15.2. Example 2: . . . . .	63
8.16.	MAC_DefaultSourceAddrLSB . . . . .	64
	8.16.1. Example 1: . . . . .	64
	8.16.2. Example 2: . . . . .	64
8.17.	MAC_ACKTimeout . . . . .	65
	8.17.1. Example 1: . . . . .	65
	8.17.2. Example 2: . . . . .	65
8.18.	PHY_PAPower . . . . .	66
	8.18.1. Example 1: . . . . .	66
	8.18.2. Example 2: . . . . .	66
8.19.	PHY_DefaultChannel . . . . .	68
	8.19.1. Example 1: . . . . .	68
	8.19.2. Example 2: . . . . .	68
8.20.	PHY_CCAThr . . . . .	69
	8.20.1. Example 1: . . . . .	69
	8.20.2. Example 2: . . . . .	69
8.21.	OpMode . . . . .	70
	8.21.1. Example 1: . . . . .	70
	8.21.2. Example 2: . . . . .	70
8.22.	CfgFlags . . . . .	71
	8.22.1. Example 1: . . . . .	72
	8.22.2. Example 2: . . . . .	72
8.23.	RpFlags . . . . .	73
	8.23.1. Example 1: . . . . .	73
	8.23.2. Example 2: . . . . .	74
8.24.	RP_NumSlots . . . . .	75
	8.24.1. Example 1: . . . . .	76
	8.24.2. Example 2: . . . . .	76

8.24.3. UART_Baudrate: Configure the UART speed . . . . .	77
8.24.4. Example 1: . . . . .	77
8.24.5. Example 2: . . . . .	77
8.25. UART_Databits . . . . .	79
8.25.1. Example 1: . . . . .	79
8.25.2. Example 2: . . . . .	79
8.26. UART_Parity . . . . .	80
8.26.1. Example 1: . . . . .	80
8.26.2. Example 2: . . . . .	80
8.27. UART_Stopbits . . . . .	82
8.27.1. Example 1: . . . . .	82
8.27.2. Example 2: . . . . .	82
8.28. RF_ConfigIndex . . . . .	83
8.28.1. Example 1: . . . . .	83
8.28.2. Example 2: . . . . .	83
8.29. RF_CCADisabled . . . . .	85
8.29.1. Example 1: . . . . .	85
8.29.2. Example 2: . . . . .	85
8.30. RF_CCACheckTime . . . . .	87
8.30.1. Example 1: . . . . .	87
8.30.2. Example 2: . . . . .	87
<b>9. Timing parameters</b>	<b>88</b>
9.1. Reset behavior . . . . .	88
9.1.1. Power-on reset . . . . .	88
9.1.2. Reset via /RESET pin . . . . .	88
9.1.3. Reset as result of a serious error condition . . . . .	88
9.2. Latencies when leaving the LPM . . . . .	88
9.3. Latencies during data transfer / packet generation . . . . .	89
<b>10. Radio parameters</b>	<b>90</b>
10.1. Channel assignment . . . . .	90
<b>11. Using the repeater functionality</b>	<b>92</b>
11.1. Setup of the network and repeater device . . . . .	93
11.2. Example network . . . . .	94
11.3. Application in parallel networks . . . . .	95
<b>12. Battery powered operation</b>	<b>96</b>
12.1. Active mode . . . . .	96
12.2. Stand-by mode . . . . .	96
<b>13. Custom firmware</b>	<b>97</b>
13.1. Custom configuration of standard firmware . . . . .	97
13.2. Customer specific firmware . . . . .	97
13.3. Customer firmware . . . . .	97
13.4. Contact for firmware requests . . . . .	98

<b>14. Firmware updates</b>	<b>99</b>
14.1. Firmware flashing using the production interface . . . . .	99
14.2. Update via ACC Software and UART . . . . .	99
<b>15. Firmware history</b>	<b>101</b>
<b>16. Design in guide</b>	<b>102</b>
16.1. Advice for schematic and layout . . . . .	102
16.2. Dimensioning of the micro strip antenna line . . . . .	104
16.3. Antenna solutions . . . . .	105
16.3.1. Wire antenna . . . . .	106
16.3.2. Chip antenna . . . . .	106
16.3.3. PCB antenna . . . . .	106
16.3.4. Antennas provided by Würth Elektronik eiSos . . . . .	107
16.3.4.1. 2600130081 - Hyperion-I - 868 MHz dipole antenna . . . . .	107
16.3.4.2. 2600130083 - Hydra-I - 915 MHz dipole antenna . . . . .	108
<b>17. Reference design</b>	<b>109</b>
17.1. Schematic . . . . .	110
17.2. Layout . . . . .	112
<b>18. Manufacturing information</b>	<b>113</b>
18.1. Moisture sensitivity level . . . . .	113
18.2. Soldering . . . . .	113
18.2.1. Reflow soldering . . . . .	113
18.2.2. Cleaning . . . . .	115
18.2.3. Potting and coating . . . . .	115
18.2.4. Other notations . . . . .	115
18.3. ESD handling . . . . .	116
18.4. Safety recommendations . . . . .	116
<b>19. Physical specifications</b>	<b>118</b>
19.1. Dimensions . . . . .	118
19.2. Weight . . . . .	118
19.3. Module drawing . . . . .	119
19.4. Footprint . . . . .	120
19.5. Antenna free area . . . . .	120
<b>20. Marking</b>	<b>121</b>
20.1. Lot number . . . . .	121
20.2. General labeling information . . . . .	122
<b>21. Information for explosion protection</b>	<b>123</b>
<b>22. Regulatory compliance information</b>	<b>124</b>
22.1. Important notice FCC . . . . .	124
22.2. Conformity assessment of the final product . . . . .	124
22.3. Exemption clause . . . . .	124

22.4.	FCC Compliance Statement (US) . . . . .	125
22.4.1.	FCC certificate . . . . .	125
22.5.	IC Compliance Statement (Canada) . . . . .	126
22.5.1.	IC certificate . . . . .	126
22.6.	FCC and IC requirements to OEM integrators . . . . .	127
22.7.	Pre-certified antennas . . . . .	128
<b>23.</b>	<b>Important notes</b>	<b>129</b>
23.1.	General customer responsibility . . . . .	129
23.2.	Customer responsibility related to specific, in particular safety-relevant applications . . . . .	129
23.3.	Best care and attention . . . . .	129
23.4.	Customer support for product specifications . . . . .	129
23.5.	Product improvements . . . . .	130
23.6.	Product life cycle . . . . .	130
23.7.	Property rights . . . . .	130
23.8.	General terms and conditions . . . . .	130
<b>24.</b>	<b>Legal notice</b>	<b>131</b>
24.1.	Exclusion of liability . . . . .	131
24.2.	Suitability in customer applications . . . . .	131
24.3.	Trademarks . . . . .	131
24.4.	Usage restriction . . . . .	131
<b>25.</b>	<b>License terms</b>	<b>133</b>
25.1.	Limited license . . . . .	133
25.2.	Usage and obligations . . . . .	133
25.3.	Ownership . . . . .	134
25.4.	Firmware update(s) . . . . .	134
25.5.	Disclaimer of warranty . . . . .	134
25.6.	Limitation of liability . . . . .	135
25.7.	Applicable law and jurisdiction . . . . .	135
25.8.	Severability clause . . . . .	135
25.9.	Miscellaneous . . . . .	135
<b>A.</b>	<b>Additional CRC8 Information</b>	<b>137</b>
A.1.	Example CRC8 Implementation . . . . .	137
A.2.	CRC8 Test Vectors . . . . .	137
<b>B.</b>	<b>Example codes for host integration</b>	<b>138</b>

## Overview of helpful application notes

### **Application note ANR008 - Wireless Connectivity Software Development Kit**

<http://www.we-online.com/ANR008>

To ease the integration of the Würth Elektronik eiSos radio modules into an application, Würth Elektronik eiSos offers the corresponding Software Development Kit (SDK) for most commonly used host processors. This SDK contains drivers and examples in C-code to communicate with the corresponding radio module. This application note shows which SDKs are available and describes how to download and use them.

### **Application note ANR010 - Range estimation**

<http://www.we-online.com/ANR010>

This application note presents the two most used mathematical range estimation models, Friis and two ray ground reflection, and its implementation in the range estimation tool of the RED-EXPERT.

### **Application note ANR015 - From 868 MHz To 915 MHz**

<http://www.we-online.com/ANR015>

Due to radio regulation laws in Europe and North America different frequencies are used in the sub-GHz range for radio data transmission. Therefore Würth Elektronik eiSos offers each product operating in the European 868 MHz range an counterpart operating in the American 915 MHz range. This application note shows which modules are comparable, where they differ and what to consider when switching from 868 to 915 MHz and vice versa.

### **Application note ANR016 - Radio module migration guide**

<http://www.we-online.com/ANR016>

Due to our long term availability policy Würth Elektronik eiSos offers beside radio modules with most recent technology and chipset still the predecessor modules. This application note describes what to consider when switching in between module generations.

# 1. Introduction

## 1.1. Operational description

The Telesto-I is a radio sub module for wireless communication between devices such as control systems, remote controls, sensors etc. It offers several radio configurations, address modes and relieves the host system of radio-specific tasks such as

- checksum calculation,
- address resolution and
- repetition of addressed but unacknowledged telegrams (if enabled).

It can be deployed wherever the wireless exchange of data packets between two or more parties is required. A serial interface (UART) whose data rate can be adjusted is available for communicating with the host system.

## 1.2. Block diagram

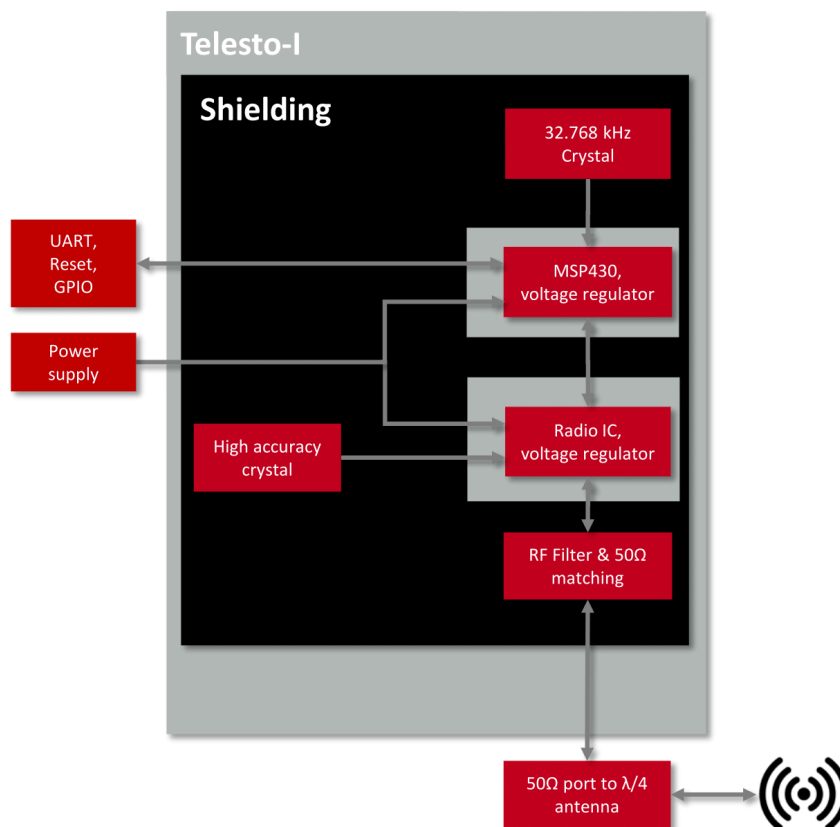

Figure 1: Block diagram

### 1.3. Ordering information

WE order code	Former order code	Description
2607021191000	AMB9625-TR	Proprietary radio module 915MHz with antenna pad, Tape & Reel
2607029291011	AMB9626-EV	Evaluation kit for AMB9626 modules
2607056291011	AMB9666	USB dongle with AMB9626 module, SMA antenna connector

Table 1: Ordering information

## 2. Electrical specifications

As not otherwise stated measured on the evaluation board Telesto-I-EV with  $T = 25\text{ °C}$ ,  $VCC = 3.3\text{ V}$  and  $50\ \Omega$  conducted.

### 2.1. Recommended operating conditions

Description	Min.	Typ.	Max.	Unit
Ambient temperature	-40		85	°C
Supply voltage (VDDS)	2.0	2.5	3.6	V

Table 2: Recommended operating conditions

### 2.2. Absolute maximum ratings

Description	Min.	Typ.	Max.	Unit
VCC	-0.3		3.9	V
Level at any module IO pin	-0.3		VCC+0.3, max 3.9	V
Output RF level		15		dBm
Input RF level			10	dBm

Table 3: Absolute maximum ratings

### 2.3. Power consumption



The transmit and receive currents are depending on the impedance matching, and therefore may vary depending on antenna selection and matching.



A stable power supply is indispensable to ensure valid operating conditions for the module. Releasing the */RESET* pin before the VCC is stable may damage the module permanently.





A stable power supply and proper antenna design and matching is indispensable to achieve the stated radio characteristics.

**2.3.1. Static**

The stated current consumption is the sum of the CPU current and the radio current, depending on the active radio mode.

Conditions: Telesto-I-EV with T = 25 °C, VCC = 3.3 V, terminated unused module pads and 50 Ω conducted.

Description	Min	Typ.	Max	Unit
TX current consumption at max output power		30		mA
RX current consumption		30		mA
Low power (LPM3), radio off, UART via ACLK		3		μA

Table 4: Power consumption

**2.4. Radio characteristics**

Conditions: Telesto-I-EV, T = 25 °C, VCC = 3.0 V, terminated unused module pads, 50 Ω conducted

Description	Min	Typ.	Max	Unit
Max output power			-2	dBm
Best input sensitivity		-106		dBm
Frequencies	902.5		927.5	MHz

Table 5: Radio characteristics

**2.5. Pin characteristics**

Property	Min	Typ.	Max	Unit
GPIO maximum current per pin		2		mA
GPIO maximum current over all		48		mA
Internal pull-up resistor	20	35	50	k $\Omega$
Internal Pull-down resistor	20	35	50	k $\Omega$

Table 6: Pin characteristics

## 2.6. Integrated flash characteristics

The integrated flash memory has only a limited number cycles. This number of flash cycles has a guaranteed min. value of 10000 and a typical value of 100000.

Hosts shall implement methods to prevent their applications from excessively using flash cycles. This can be achieved by always performing a `CMD_GET_REQ` before any `CMD_SET_REQ` and other command that uses flash cycles.

### 3. Pinout

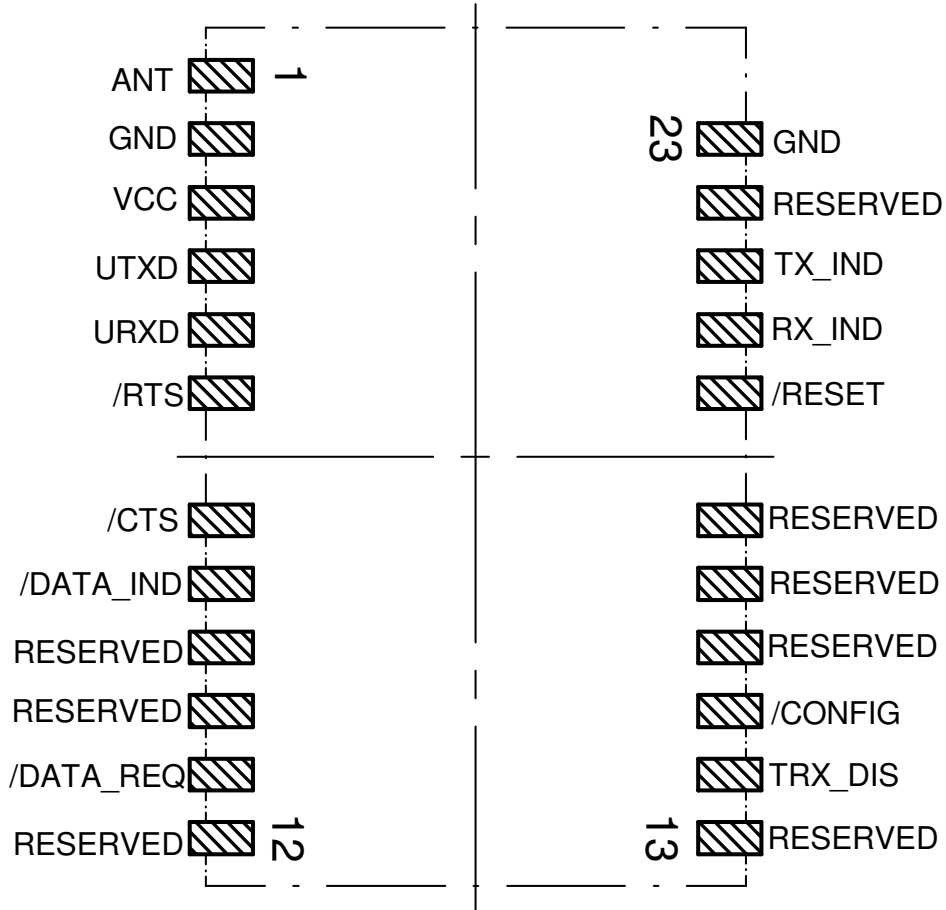

Figure 2: Pinout

No	Designation	I/O	Description
1	<i>ANT</i>	I/O	Antenna connection, 50 Ω
2	<i>GND</i>	Supply	Ground
3	<i>VCC</i>	Supply	Supply voltage
4	<i>UTXD</i>	Output	UART TX (module transmission)
5	<i>URXD</i>	Input	UART RX (module reception)
6	<i>/RTS</i>	Output	UART ready to send. HIGH level signalizes a busy module UART buffer. While HIGH, all received UART bytes will be discarded.

7	<i>/CTS</i>	Input	UART clear to send. HIGH signal indicates host busy. Disabled by default. <b>If the pin function is disabled, connect it to GND.</b>
8	<i>/DATA_IND</i>	Output	Packet receive indication. Goes LOW as soon as a valid packet with correct address is received via radio, stays LOW for and additional <i>UART_DIDelay</i> and remains LOW as long as the output via UART continues.
9	<i>RESERVED</i>	Output	Reserved. <b>Do not connect.</b>
10	<i>RESERVED</i>	Output	Reserved. <b>Do not connect.</b>
11	<i>/DATA_REQUEST</i>	Input	A falling edge triggers the wireless transmission of buffered data (transparent <i>OpMode</i> only). When enabled this pin uses an internal pull-up resistor. Can be disabled by <i>CfgFlags</i> . <b>If the pin function is disabled, connect it to GND.</b>
12	<i>RESERVED</i>	Output	Reserved. <b>Do not connect.</b>
13	<i>RESERVED</i>	Output	Reserved. <b>Do not connect.</b>
14	<i>TRX_DISABLE</i>	Input	Switches the radio receive function off when a HIGH level is applied. <b>The pin level must be hold LOW during the module boot up.</b> <b>Connect to GND if not needed.</b>
15	<i>/CONFIG</i>	Input	Switch the module's <i>OpMode</i> on a falling edge detection. Can be disabled by <i>CfgFlags</i> . <b>Connect to GND if function is disabled.</b>
16	<i>RESERVED</i>	Output	Reserved. <b>Do not connect.</b>
17	<i>TEST</i>	Debug	Test Line. <b>Do not connect.</b>
18	<i>RESERVED</i>	Output	Reserved <b>Do not connect.</b>
19	<i>/RESET</i>	Input	Module internal pull-up, a rising edge will release module from reset, LOW will hold module in reset state.
20	<i>TX_INDICATE</i>	Output	Shows radio activity, HIGH on radio TX. Can be enabled by <i>CfgFlags</i> .
21	<i>RX_INDICATE</i>	Output	Shows radio activity, HIGH on radio RX. Can be enabled by <i>CfgFlags</i> .
22	<i>RESERVED</i>	Output	Reserved. <b>Do not connect.</b>
23	<i>GND</i>	Supply	Ground

Table 7: Pinout

## 4. Quickstart

### 4.1. Minimal pin configuration

In the factory state, the modules are immediately ready for operation; the following pins are required in the minimal configuration: *VCC*, *GND*, *UTXD* and *URXD*.

If the module has to be connected to a PC, an adapter (TTL to RS-232 or TTL to USB) has to be used. The Telesto-I-EV is suited for this.

In the default configuration all module inputs (*TRX\_DISABLE* and */CONFIG*) are activated and must be connected as shown in table 7. If the function of the */DATA\_REQUEST* pin is enabled (see chapter 8.22), this pin has an internal pull-up resistor.



If *TRX\_DISABLE* is used by the host it must be set to *GND* during start-up / after reset till the module's start-up is completed. The module will wait for this pin to go to *GND* level before finishing its start-up procedure. The module's UART or function pins (such as */CONFIG*) will not be available until the start-up is finished.

### 4.2. Power up

Condition:  $\Delta t > 2\text{ms}$ .

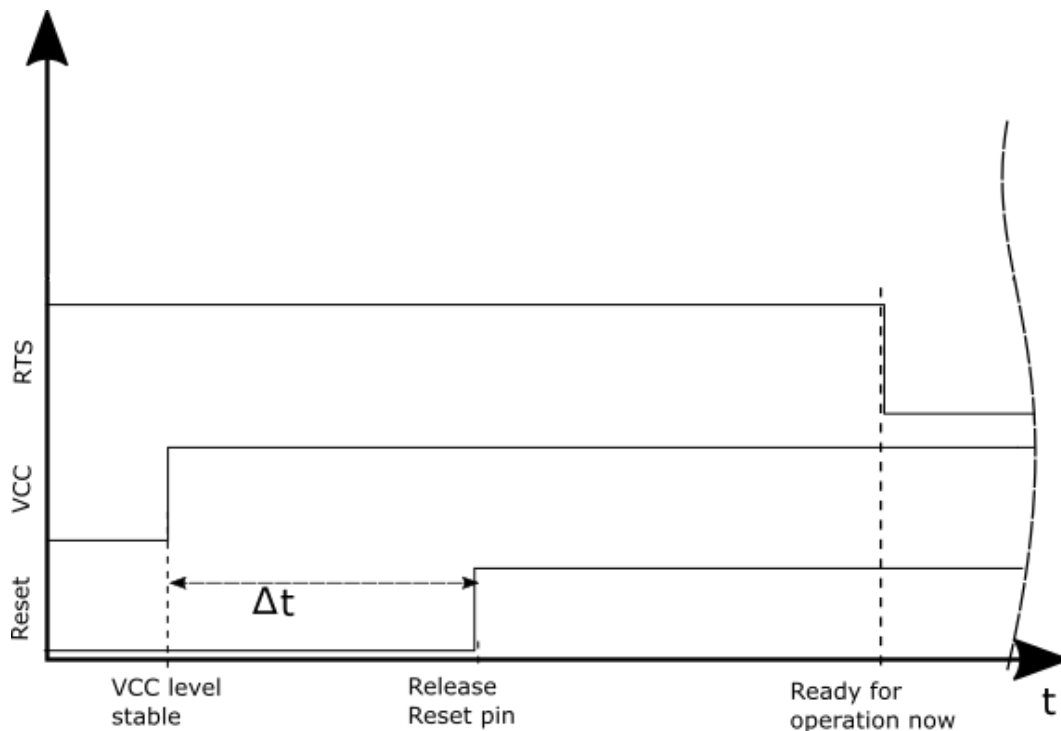



Figure 3: Power up

### 4.3. Quickstart example



In factory state the module is in transparent mode.

**Sending and receiving: Hello World in transparent mode**

Connect your pair of modules, EV-boards or USB-sticks with the PC as explained in chapter 4.1. Please make sure you have a minimum distance of 3 meters between the two modules or devices to avoid over modulation. When short distances are needed, you could reduce the PHY\_PAPower to a minimum.

When the connection to the PC is done, please use a terminal tool of your choice. For convenience we assume you selected the tool *hterm*. Select the two corresponding COM ports and open them with a configuration of 9600 Baud, 8 Data bits, 1 Stop bit and Parity set to None.



Enter the string "Hello World" into the input line of hterm and use the "ASend" button followed by pushing the "start" button to send the data once.

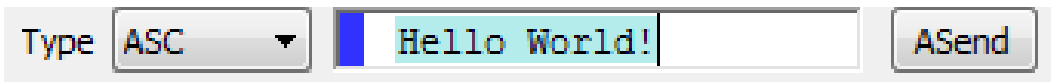

This data will be received by the second module and shows up as received data in the second hterm instance. You may send any string of size 1 to 128 characters from one module to the other.

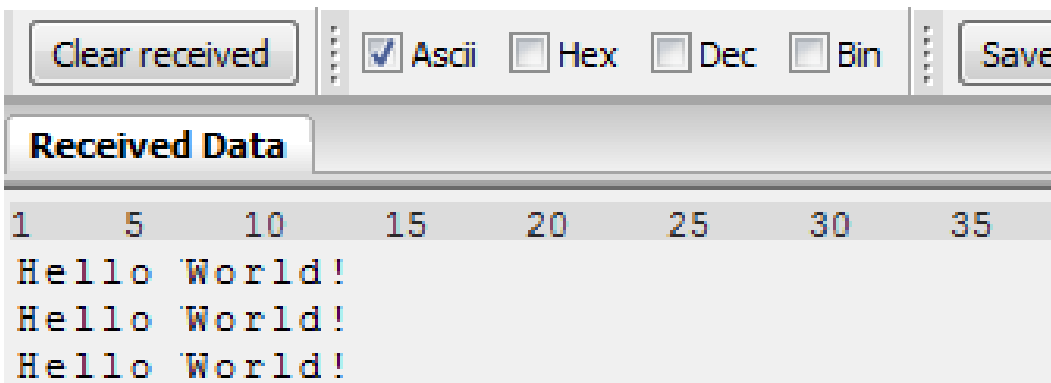

You just used the so called "transparent mode" of the modules to send your data. The address mode that was used is "0". Thus all radio frames are broadcasts that can be received by anyone listening with an Telesto-I in default settings. The frame you sent was generated using the timeout method.

Besides the transparent mode, that is suited for transparent data transmission, the so called "command mode" allows both, the module configuration and the data transmission, using a predefined command interface (see chapter 7).

**Sending and receiving: Hello World in command mode**



Be sure that the module runs in command mode by default.

Connect your pair of modules, EV-boards or USB-sticks with the PC as explained in chapter 4.1. Please make sure you have a minimum distance of 3 meters between the two modules or devices to avoid over modulation. When short distances are needed, you could reduce the PHY\_PAPower to a minimum.

A terminal program, for example hterm, is used to perform the communication over the COM ports. The two corresponding COM ports have to be selected and opened with a configuration of 9600 Baud, 8 Data bits, 1 Stop bit and Parity set to none.

Baud 
Data 
Stop 
Parity

As soon as the module is ready for operation (at start-up or after a reset) a CMD\_RESET\_CNF message (0x02 0x45 0x01 0x00 0x46) is sent on the UART. It may be necessary to push the reset button (or perform CMD\_RESET\_REQ) to see this message.



If the CMD\_RESET\_CNF message did not occur after resetting, the module is not in command mode.

In factory state the default address mode is "0", which means that all radio frames are broadcasts that can be received by anyone listening with an Telesto-I in default settings.

**Transmitter**

To send the string "Hello World", the corresponding CMD\_DATA\_REQ has to be inserted into the input line of hterm. The command CMD\_DATA\_REQ has the following structure:

Start signal	Command	Payload Length	Payload	CS
0x02	0x00	1 Byte	Payload length	1 Byte

In this case the payload has a length of 12 (0x0C) bytes and 0x48 0x65 0x6C 0x6C 0x6F 0x20 0x57 0x6F 0x72 0x6C 0x64 0x21 (Hello World!) is the payload data. The checksum CS is a XOR combination of all previous bytes, which in this case is 0x0F.

Using the "ASend" button followed by pushing the "start" button sends the data once.

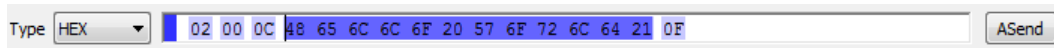

The sending module answers with a `CMD_DATA_CNF` to confirm that the request has been received.

**Receiver**

In factory state, the second module receiving this packet outputs a `CMD_DATAEX_IND` message which format is as follows:

Start signal	Command	Payload Length + 1	Payload	RSSI	CS
0x02	0x81	1 Byte	Payload length	1 Byte	1 Byte

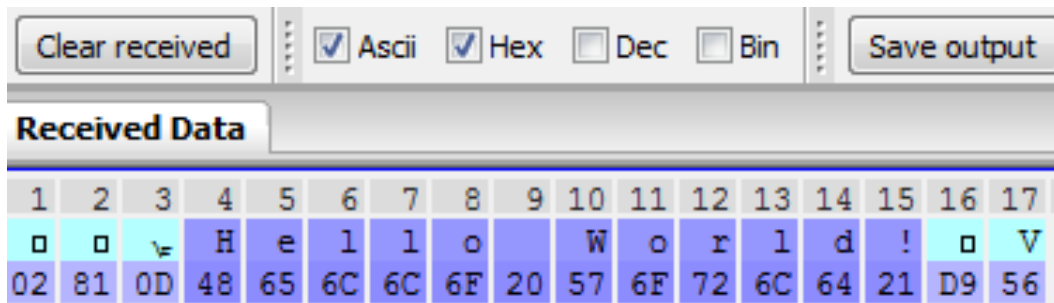

Thus the `CMD_DATAEX_IND` message informs us that we received a packet with payload of 0x0D (13) bytes. 12 of these bytes are user payload (0x48 0x65 0x6C 0x6C 0x6F 0x20 0x57 0x6F 0x72 0x6C 0x64 0x21 = Hello World!) and one byte is the RSSI value (here 0xD9, which is two's complement for -39 dBm) directly outputted behind the payload, before the checksum.



## 5. Functional description

### 5.1. Operating modes

The Telesto-I can be used in the following operating modes:

1. Transparent mode (transparent data transmission)
2. Command mode (module configuration and data transmission using the predefined command interface)

The operating mode after power-up can be configured by means of the `OpMode` parameter. By default, the module operates in transparent mode. Starting in the command mode, the module responds with a `CMD_SET_MODE_CNF` telegram.



We highly recommended to only use Command mode.

#### 5.1.1. Switching from transparent to command mode

The command mode can be entered by applying a falling edge on the `/CONFIG` pin. The detection of the falling edge on the `/CONFIG` pin can be disabled using the user setting `CfgFlags`.

The successful switchover is acknowledged by a `CMD_SET_MODE_CNF` telegram indicating command mode.

The switchover can only occur when no data is being received by wireless transmission or UART interface (approximately 100  $\mu$ s after `/RTS` goes low and indicates readiness).

#### 5.1.2. Switching from command to transparent mode

The transparent mode can be entered by applying a falling edge on the `/CONFIG` pin or by using the command `CMD_SET_MODE_REQ`. The detection of the falling edge on the `/CONFIG` pin can be disabled using the user setting `CfgFlags`.

The successful switchover is acknowledged by a `CMD_SET_MODE_CNF` telegram indicating transparent mode.

The switchover can only occur when no data is being received by wireless transmission or UART interface (approximately 100  $\mu$ s after `/RTS` goes low and indicates readiness).



Recommendation:

Automatic switching to a specific mode can be realized by applying falling edges on the `/CONFIG` pin as long as the needed `CMD_SET_MODE_CNF` is returned:

- 0x02 0x44 0x01 0x10 0x57 telegram indicating command mode
- 0x02 0x44 0x01 0x00 0x47 telegram indicating transparent mode

**5.1.3. Transparent mode**

In this mode, data is received via the serial interface and initially buffered. As soon as a specific condition is met, the RF telegram is generated with a preamble, checksum, and address information (optional).

To initiate an RF transmission, several options are available, listed in table 8.

Start Condition	Description	Dependent Usersettings
<b>Timeout</b>	Transmission starts if no new character is detected within a configurable time period after receiving a character via UART. The timeout is reset every time a new character is received.	UART_Timeout UART_PktMode
<b>End-Of-Text-Character</b>	Transmission begins when the preconfigured character is transmitted via UART.	UART_PktMode UART_ETXChar
<b>Fixed Packet Size</b>	Transmission starts when the preconfigured number of bytes is reached in the RX buffer of the UART.	UART_PktSize UART_RTSLimit UART_PktMode
<b>/Data Request Pin</b>	The transmission starts as soon as a falling edge is detected on the <code>/DATA_REQUEST</code> pin.	CfgFlags

Table 8: Communication in transparent mode

The `UART_PktMode` parameter (see chapter 8.3) can be used to determine which of the listed combinations is to be used.

**5.1.4. /RTS signal, module busy**

`/RTS` signalizes a busy UART buffer of the module which means, when `/RTS` is set HIGH, all incoming UART bytes will be discarded.

`/RTS` is set when any of the events in the prior chapter has occurred.



We highly recommended to implement the module `/RTS` pin handling into the host to prevent data loss.

### 5.1.5. Command mode

This operating mode primarily serves module configuration. The module acts as a slave and can be fully controlled by an external host using the commands of the command interface (see chapter 8.30).

It can also be used for wireless transmission of payload data providing a feedback dependent on the transmission success.

## 5.2. Adopting parameters to fit your application

The non-volatile parameters (see chapter 8) can only be changed in the command mode by using the `CMD_SET_REQ` command. This command will need the following parameters:

- memory position of the parameter
- the new value that shall be applied to this parameter

Furthermore, there are volatile settings that can be accessed by explicit commands for each parameter. All available commands are introduced in chapter 7.

## 5.3. Device addressing and wireless monitoring

Settings like the module address can only be modified in the command mode. Thus we recommend to permanently operate in command mode by setting the user settings parameter `OpMode` to the value of `0x10` (16).

To use non-broadcast transmissions you need to adopt the following non-volatile settings:

- `MAC_AddrMode` (mode 1 or 2 should be used depending on the number of addresses you need)
- `MAC_DefaultSourceAddrLSB` as the local address for each device of your network, each member of the network will need an unique address. A value of 255 is invalid.
- `MAC_DefaultSourceNetID`, as the local network address for each device of your network, each member of the network will need an unique address. A value of 255 is invalid.

In command mode, the command `CMD_DATAEX_REQ`, that has the destination address as an own parameter, can be used to send your data to the specified address. A broadcast message can still be achieved when using `0xFF` (255) for both destination address LSB and destination net ID.

The address resolution can be disabled ("packet sniffer") with bit 7 in the `CfgFlags`. A module configured in this way will receive all data packets and forward them to the serial interface, regardless of the addressing mode. In sniffer mode, the module does not send any acknowledgment.

## 6. Host connection

### 6.1. Serial interface: UART

The configuration in factory state of the UART is 9600 Baud with data format of 8 data bits, no parity and 1 stop bit ("8n1"). The baud rate of the UART can be configured by means of the UserSetting `UART_Baudrate`. The data format can be modified by the UserSettings `UART_Databits`, `UART_Parity` and `UART_Stopbits`.

Since the UART speed is derived from a digitally calibrated oscillator, this may result in variations of up to  $\pm 2\%$ . When the UART Clock is derived from the ACLK (i.e. 32768Hz crystal) of the module this variation can be up to  $\pm 47\%$ . Details to this behavior can be extracted from TI's Family User's Guide for MSP430x5xx  $\mu$ C family.

The output of characters on the serial interface runs with secondary priority. For this reason, short interruptions may occur between the outputs of individual successive bytes. The host must not implement too strict timeouts between two bytes to be able to receive packets that have interruptions in between.

For the direction "host to module" the host must respect byte-wise the line `/RTS`, which will indicate that the next byte of the packet can be received by the module.

## 7. The command interface

### 7.1. Overview

In the command mode, communication with the module occurs in form of predefined commands. These commands must be sent in telegrams according to the format described in table 9.

Start signal	Command	No. of data	Data	Checksum
--------------	---------	-------------	------	----------

Table 9: Telegram format in the command mode

**Start signal:** 0x02 (1 byte)

**Command:** One of the predefined commands according to chapter 7.2 (1 byte)

**No. of data:** Specifies the number of data in the following field of variable length and is limited to 128 in order to prevent buffer overflow (1 byte). With appropriate commands values > 128 can occur.

**Data:** Variable number of data or parameters (maximum 128 byte, payload plus 6 byte parameter, LSB first)

**Checksum:** Byte wise XOR combination of the preceding fields including the start signal, i.e.  $0x02 \hat{=} \text{command} \hat{=} \text{no. of data} \hat{=} \text{data byte } 0 \dots$  (1 byte)



Host integration example codes for checksum calculation and command frame structure can be found in annex A and B, as well as in the *Wireless Connectivity SDK*.

Using a specific command, data can also be sent via RF, i.e. the module can be operated entirely in the command mode. Only in this way quick channel changes, can be realized.

If no new signal is received for `UART_Timeout` milliseconds after receiving the STX signal, the unit will wait for a new start signal.

On each command follows a response from the module to the host.

## 7.2. Message overview

Start signal	CMD	Message name	Short description
<b>Requests</b>			
0x02	0x00	CMD_DATA_REQ	Send data to configured address
0x02	0x01	CMD_DATAEX_REQ	Send data to specific address
0x02	0x02	CMD_DATARETRY_REQ	Resend the transmission of the data submitted earlier
0x02	0x04	CMD_SET_MODE_REQ	Change into new operating mode
0x02	0x05	CMD_RESET_REQ	Reset module
0x02	0x06	CMD_SET_CHANNEL_REQ	Change the RF channel
0x02	0x07	CMD_SET_DESTNETID_REQ	Set the destination network ID
0x02	0x08	CMD_SET_DESTADDR_REQ	Set the destination address
0x02	0x09	CMD_SET_REQ	Change the user settings
0x02	0x0A	CMD_GET_REQ	Read the user settings
0x02	0x0B	CMD_SERIALNO_REQ	Request the individual serial number of the module
0x02	0x0C	CMD_FWRELEASE_REQ	Request the firmware version of the module
0x02	0x0D	CMD_RSSI_REQ	Request RSSI of last packet
0x02	0x0E	CMD_ERRORFLAGS_REQ	Returns internal error states
0x02	0x11	CMD_SET_PAPOWER_REQ	Change the RF TX power
0x02	0x12	CMD_FACTORY_RESET_REQ	Perform a factory reset
<b>Confirmations</b>			
0x02	0x40	CMD_DATA_CNF	Data has been sent
0x02	0x42	CMD_DATARETRY_CNF	Data has been resent
0x02	0x44	CMD_SET_MODE_CNF	Operating mode has been changed
0x02	0x45	CMD_RESET_CNF	Reset request received
0x02	0x46	CMD_SET_CHANNEL_CNF	Channel has been updated
0x02	0x47	CMD_SET_DESTNETID_CNF	Destination network ID has been updated
0x02	0x48	CMD_SET_DESTADDR_CNF	Destination address has been updated
0x02	0x49	CMD_SET_CNF	User settings have been updated
0x02	0x4A	CMD_GET_CNF	Return the requested user setting values
0x02	0x4B	CMD_SERIALNO_CNF	Serial number request received
0x02	0x4C	CMD_FWRELEASE_CNF	Firmware version request received

0x02	0x4D	CMD_RSSI_CNF	RSSI request received
0x02	0x4E	CMD_ERRORFLAGS_CNF	Internal error states have been returned
0x02	0x51	CMD_SET_PAPOWER_CNF	RF TX power has been changed
0x02	0x52	CMD_FACTORY_RESET_CNF	Factory reset request received
<b>Indications</b>			
0x02	0x80	CMD_REPEAT_IND	Data has been repeated
0x02	0x81	CMD_DATAEX_IND	Data has been received

Table 10: Message overview

### 7.3. Data transfer & reception in the command mode

This group of commands includes the commands that are used to either request a radio telegram to be sent or indicates a received frame.

#### 7.3.1. CMD\_DATA\_REQ

This command serves the simple data transfer in the command mode. Transmission takes place on the configured channel to the previously parameterized destination address.

This command is especially suitable for transmission for a point-to-point connection. The number of payload data bytes is limited to 128.

Format:

Start signal	Command	Payload length	Payload	CS
0x02	0x00	1 Byte	Payload length	1 Byte

Response CMD\_DATA\_CNF:

Start signal	Command   0x40	Length	Status	CS
0x02	0x40	0x01	1 Byte	1 Byte

**0x00:** ACK received or not requested (MAC\_NumRetrys is 0 or MAC\_AddrMode is 0)

**0x01:** no ACK received

#### 7.3.1.1. Example 1:

Transmit "Hello" (0x48 0x65 0x6C 0x6C 0x6F).

Command:

Start signal	Command	Payload length	Payload	CS
0x02	0x00	0x05	0x48 0x65 0x6C 0x6C 0x6F	0x45

Response:

Start signal	Command   0x40	Length	Status	CS
0x02	0x40	0x01	0x00	0x43

Transmission of "Hello" was successful.



**7.3.2. CMD\_DATAEX\_REQ**

This command serves data transfer in a network with several parties. Both the channel to use and the destination address (depending on the parameterized addressing mode) are specified along with the command. The number of payload data bytes is limited to 128. The entered channel, destination network and destination address are loaded into the volatile runtime settings and thus kept until the system is reset.

Format in addressing mode 0:

Start signal	Command	Payload length + 1	Channel	Payload	CS
0x02	0x01	1 Byte	1 Byte	Payload length	1 Byte

Format in addressing mode 1:

Start signal	Command	Payload length + 2	Channel	Destination address	Payload	CS
0x02	0x01	1 Byte	1 Byte	1 Byte	Payload length	1 Byte

Format in addressing mode 2:

Start signal	Command	Payload length + 3	Channel	Destination network ID	Destination address	Payload	CS
0x02	0x01	1 Byte	1 Byte	1 Byte	1 Byte	Payload length	1 Byte

Response CMD\_DATA\_CNF:

Start signal	CMD_DATA_REQ   0x40	Length	Status	CS
0x02	0x40	0x01	1 Byte	1 Byte

**0x00:** ACK received or not requested (MAC\_NumRetrys is 0 or MAC\_AddrMode is 0)

**0x01:** no ACK received

**0x02:** invalid channel selected

**7.3.2.1. Example 1:**

Transmit "Goodbye" in addressing mode 1 on channel 108 (0x6A) to address 5.

Command:

Start signal	Command	Payload length + 2	Channel	Destination address	Payload	CS
0x02	0x01	0x09	0x6A	0x05	0x47 0x6F 0x6F 0x64 0x62 0x79 0x65	0x38

Response:

Start signal	CMD_DATA_REQ   0x40	Length	Status	CS
0x02	0x40	0x01	0x00	0x43

"Goodbye" was successfully transmitted.

### 7.3.3. CMD\_DATAEX\_IND

This telegram indicates the reception of data bytes and represents the counterpart to the commands CMD\_DATA\_REQ and CMD\_DATAEX\_REQ. Apart from the RX field strength (RSSI value), this telegram also specifies the sender address (depending on the parameterized addressing mode).

Format in addressing mode 0:

Start signal	Command	Payload length + 1	Payload	RSSI	CS
0x02	0x81	1 Byte	Payload length	1 Byte	1 Byte

Format in addressing mode 1:

Start signal	Command	Payload length + 2	Sender address	Payload	RSSI	CS
0x02	0x81	1 Byte	1 Byte	Payload length	1 Byte	1 Byte

Format in addressing mode 2:

Start signal	Command	Payload length + 3	Sender network ID	Sender address	Payload	RSSI	CS
0x02	0x81	1 Byte	1 Byte	1 Byte	Payload length	1 Byte	1 Byte

#### 7.3.3.1. Example 1:

Data was received in MAC\_AddrMode 0:

Start signal	Command	Payload length + 1	Payload	RSSI	CS
0x02	0x81	0x0D	0x48 0x65 0x6C 0x6C 0x6F 0x20 0x57 0x6F 0x72 0x6C 0x64 0x21	0xD9	0x56

The CMD\_DATAEX\_IND message informs us that we received a packet with payload of 0x0D (13) bytes. 12 of these bytes are user payload (0x48 0x65 0x6C 0x6C 0x6F 0x20 0x57 0x6F 0x72 0x6C 0x64 0x21 = Hello World!) and one byte is the RSSI value (here 0xD9, which is two's complement for -39 dBm) directly outputted behind the payload, before the checksum.

**7.3.4. CMD\_DATARETRY\_REQ**

This command resends the transmission of the data submitted earlier on with CMD\_DATA\_REQ or CMD\_DATAEX\_REQ. Thus, the data does not need to be transmitted again via UART.

The buffered data is lost as soon as new data is sent via UART or data is received via wireless transmission.

Format:

Start signal	Command	0x00	CS
0x02	0x02	0x00	1 Byte

Response CMD\_DATARETRY\_CNF:

Start signal	Command   0x40	Length	Status	CS
0x02	0x42	0x01	1 Byte	1 Byte

Status:

**0x00:** ACK received, only possible if MAC\_NumRetrys is not 0; or none is requested

**0x01:** no ACK received

**0x03:** no data available (e.g., overwritten by wireless data reception)

**7.3.5. CMD\_REPEAT\_IND**

This command indicates that the module has repeated a data packet when acting in repeater mode. The source address and NetID is the address of the first sender of the RF packet, the destination address and NetID is the address of the device that is supposed to receive the RF packet.

Format in addressing mode 0:

Start signal	Command	Length	Status	Addressing mode	CS
0x02	0x80	0x02	1 Byte	0x00	1 Byte

Format in addressing mode 1:

Start signal	Command	Length	Status	Addressing mode	Destination address	Source address	CS
0x02	0x80	0x04	1 Byte	0x01	1 Byte	1 Byte	1 Byte

Format in addressing mode 2:

Start signal	Command	Length	Status	Address. mode	Dest. NetID	Dest. address	Source NetID	Source address	CS
0x02	0x80	0x06	1 Byte	0x02	1 Byte	1 Byte	1 Byte	1 Byte	1 Byte

**Status:**

**0x00:** Packet successfully repeated

**0x01:** Failed

## 7.4. Requesting parameters and actions

This group includes all commands that will return read-only parameters or request actions in the module.

### 7.4.1. CMD\_FWRELEASE\_REQ

This command is used to request the firmware version of the module.

Format:

Start signal	Command	Length	CS
0x02	0x0C	0x00	0x0E

Response CMD\_FWRELEASE\_CNF:

Start signal	Command   0x40	Length	Firmware version	CS
0x02	0x4C	0x03	3 Bytes	1 Byte

The main version number is returned first, followed by the secondary version number and the revision number.

#### 7.4.1.1. Example 1:

Format:

Start signal	Command	Length	CS
0x02	0x0C	0x00	0x0E

Response:

Start signal	Command   0x40	Length	Firmware version	CS
0x02	0x4C	0x03	0x03 0x03 0x04	0x49

The firmware version of the module is 3.3.4.

### 7.4.2. CMD\_SERIALNO\_REQ

This command can be used to query the individual serial number of the module.

Format:

Start signal	Command	Length	CS
0x02	0x0B	0x00	0x09

Response CMD\_SERIALNO\_CNF:

Start signal	Command   0x40	Length	Serial number	CS
0x02	0x4B	0x04	4 Bytes	1 Byte

For the serial number, the most significant byte (MSB), which identifies the product (product ID), is returned first.

### 7.4.3. CMD\_RESET\_REQ

This command triggers a software reset of the module. The reset is performed after the acknowledgement is transmitted.

Format:

Start signal	Command	0x00	CS
0x02	0x05	0x00	0x07

Response CMD\_RESET\_CNF:

Start signal	Command   0x40	Length	Status	CS
0x02	0x45	0x01	1 Byte	1 Byte

Status:

**0x00:** success

### 7.4.4. CMD\_RSSI\_REQ

This command returns the RX level of the last received packet determined by the transceiver IC in the form of a signed two's complement.

Format:

Start signal	Command	Length	CS
0x02	0x0D	0x00	0x0F

Response CMD\_RSSI\_CNF:

Start signal	Command   0x40	Length	RX level	CS
0x02	0x4D	0x01	1 Byte	1 Byte

The delivered RSSI delivery is in two's complement.

The relation between the calculated value and the physical RX level in dBm is not linear across the entire operating range but can be estimated as linear in the range from -110 to -30 dBm.

**7.4.4.1. Example 1:**

Format:

Start signal	Command	Length	CS
0x02	0x0D	0x00	0x0F

Response:

Start signal	Command   0x40	Length	RX level	CS
0x02	0x4D	0x01	0xBD	0xF3

The value obtained in this way delivers the RX level in dBm as follows:

$$0xDB_{hex} = 10111101_{bin} \Rightarrow 1 \times -128 + 0 \times 64 + 1 \times 32 + 1 \times 16 + 1 \times 8 + 1 \times 4 + 0 \times 2 + 1 \times 1 = -67dBm$$

**7.4.5. CMD\_ERRORFLAGS\_REQ**

This command returns internal error states.

Format:

Start signal	Command	Length	CS
0x02	0x0E	0x00	0x0C

Response CMD\_ERRORFLAGS\_CNF:

Start signal	Command   0x40	Length	Error flags	CS
0x02	0x4E	0x02	2 Bytes	1 Byte

The value of "0" returned by the error flag implies that no error has occurred. The value is reset either after a query or by a reset.

The meaning of the error flags is not described in detail in this context.



## 7.5. Modification of volatile parameters

This group contains all functions that will modify runtime settings while the module is running. These settings are all volatile and will be reset to defaults on a reset of the module.

### 7.5.1. CMD\_SET\_MODE\_REQ

This command is used to toggle the operating mode, e.g. to exit the command mode. The new operating mode is loaded into the volatile runtime settings. This and all other commands can be used in command mode only.

The following operating modes are defined:

- Transparent mode: 0x00
- Command mode: 0x10

Format:

Start signal	Command	Length	Desired operating mode	CS
0x02	0x04	0x01	0x00	0x07

Response CMD\_SET\_MODE\_CNF:

Start signal	Command   0x40	Length	Newly configured operating mode	CS
0x02	0x44	0x01	1 Byte	1 Byte

### 7.5.2. Example 1:

Enter the transparent mode.

Format:

Start signal	Command	Length	Desired operating mode	CS
0x02	0x04	0x01	0x00	0x07

Response:

Start signal	Command   0x40	Length	Newly configured operating mode	CS
0x02	0x44	0x01	0x00	0x47

The operating mode has been successfully changed to transparent mode.

### 7.5.3. CMD\_SET\_PAPOWER\_REQ

This command is used to set the RF TX-power. Unlike the user settings parameter PHY\_PApower, this is a volatile runtime parameter, but it is handled in the same way. Thus see section 8.18 for more information.

The power value is entered as a complement on two.

Format:

Start signal	Command	Length	Power	CS
0x02	0x11	0x01	1 Byte	1 Byte

Response CMD\_SET\_PAPOWER\_CNF:

Start signal	Command   0x40	Length	Power	CS
0x02	0x51	0x01	1 Byte	1 Byte

#### 7.5.3.1. Example 1:

Set the power to 14dBm.

Format:

Start signal	Command	Length	Power	CS
0x02	0x11	0x01	0x0E	0x1C

Response:

Start signal	Command   0x40	Length	Power	CS
0x02	0x51	0x01	0x0E	0x5C

The new RF power is 14dBm.

### 7.5.4. CMD\_SET\_CHANNEL\_REQ

This command is used to select the radio channel. Unlike the user settings parameter PHY\_DefaultChannel, this is a volatile runtime parameter.

Format:

Start signal	Command	Length	Channel	CS
0x02	0x06	0x01	1 Byte	1 Byte

Response CMD\_SET\_CHANNEL\_CNF:

Start signal	Command   0x40	Length	Channel	CS
0x02	0x46	0x01	1 Byte	1 Byte

**7.5.4.1. Example 1:**

Set the channel to 108.

Format:

Start signal	Command	Length	Channel	CS
0x02	0x06	0x01	0x6C	0x69

Response:

Start signal	Command   0x40	Length	Channel	CS
0x02	0x46	0x01	0x6C	0x29

The new channel is 108.

**7.5.5. CMD\_SET\_DESTNETID\_REQ**

This command serves to configure the destination network ID in addressing mode 2. Unlike the user settings parameter MAC\_DefaultDestNetID, this is a volatile runtime parameter.

Format:

Start signal	Command	Length	Destination network ID	CS
0x02	0x07	0x01	1 Byte	1 Byte

Response CMD\_SET\_DESTNETID\_CNF:

Start signal	Command   0x40	Length	Status	CS
0x02	0x47	0x01	1 Byte	1 Byte

Status:

**0x00:** success

### 7.5.6. CMD\_SET\_DESTADDR\_REQ

This command serves to configure the destination address in addressing modes 1 and 2. Unlike the user settings parameter `MAC_DefaultDestAddrLSB`, this is a volatile runtime parameter.

Format:

Start signal	Command	Length	Destination address	CS
0x02	0x08	0x01	1 Byte	1 Byte

Response `CMD_SET_DESTADDR_CNF`:

Start signal	Command   0x40	Length	Status	CS
0x02	0x48	0x01	1 Byte	1 Byte

Status:

**0x00:** success

## 7.6. Modification of non-volatile parameters

The non-volatile parameters are also called user settings and are stored in a special flash location.

### 7.6.1. CMD\_SET\_REQ

This command enables direct manipulation of the parameters in the module's non-volatile user settings. The respective parameters are accessed by means of the memory positions described in chapter 8.

You can modify individual or multiple consecutive parameters in the memory at the same time. The sum of memory position and forwarded data has to be less than the total size of the user settings (however a max. of 128 Bytes). Otherwise the package is not acknowledged.

The module always makes a local copy of the user settings, then the new values are copied into the respective memory area and finally the complete user settings are rewritten.

Parameters of 2 or more bytes have to be transferred with the LSB first.



The changed parameters only take effect after a restart of the module. This can be done by a `CMD_RESET_REQ`.



The validity of the specified parameters is not verified. Incorrect values can result in device malfunction!



To save the parameters in the flash memory of the module, the particular memory segment must first be flushed entirely and then restored from RAM. If a reset occurs during this procedure (e.g. due to supply voltage fluctuations), the entire memory area may be destroyed.

In this case, the module may no longer be operable, which means that the firmware must be re-installed via "ACC V3", in which user settings can also be configured and verified.



Recommendation: First verify the configuration of the module with `CMD_GET_REQ` and only write if required.

Format:

Start signal	Command	Length + 2	Memory position	Length	Parameter	CS
0x02	0x09	1 Byte	1 Byte	1 Byte	Length	1 Byte

Response CMD\_SET\_CNF:

Start signal	Command   0x40	Length	Status	CS
0x02	0x49	0x01	1 Byte	1 Byte

**Status:**

**0x00:** Request successfully received and processed

**0x01:** invalid memory position (write access to unauthorized area > 127 / 0xFF)

**0x02:** invalid number of bytes to be written (write access to unauthorized area > 0xFF)

**7.6.1.1. Example 1:**

Setting the number of wireless retries to 5 (parameter MAC\_NumRetrys, memory position 20).

Command:

Start signal	Command	Length + 2	Memory position	Length	Parameter	CS
0x02	0x09	0x03	0x14	0x01	0x05	0x18

Response:

Start signal	Command   0x40	Length	Status	CS
0x02	0x49	0x01	0x00	0x4A

Request successfully received and processed

**7.6.1.2. Example 2:**

Setting parameter UART\_Baudrate on 115200 Baud (memory position 80 and length 4).

Command:

Start signal	Command	Length + 2	Memory position	Length	Parameter	CS
0x02	0x09	0x06	0x50	0x04	0x00 0xC2 0x01 0x00	0x9A

Response:

Start signal	Command   0x40	Length	Status	CS
0x02	0x49	0x01	0x00	0x4A

Request successfully received and processed

**7.6.2. CMD\_GET\_REQ**

This command can be used to query individual or multiple user settings parameters. The requested number of bytes from the specified memory position are returned.

You can query individual or multiple consecutive parameters in the memory at the same time. The sum of the memory position and requested data must not be more than the total size of the user-settings (however a max. of 128 Bytes). Otherwise no data will be returned.

Parameters of 2 or more bytes will be transmitted LSB first.

Format:

Start signal	Command	Length	Memory position	Amount of Bytes	CS
0x02	0x0A	0x02	1 Byte	1 Byte	1 Byte

Response CMD\_GET\_CNF:

Start signal	Command   0x40	Length + 2	Memory position	Length	Parameter	CS
0x02	0x4A	1 Byte	1 Byte	1 Byte	Length Bytes	1 Byte

Read access to the memory area outside the user settings is blocked.

**7.6.2.1. Example 1:**

Read out the parameter `UART_Baudrate` (memory position 80 and length 4).

Command:

Start signal	Command	Length	Memory position	Amount of Bytes	CS
0x02	0x0A	0x02	0x50	0x04	0x5E

Response:

Start signal	Command   0x40	Length + 2	Memory position	Length	Parameter	CS
0x02	0x4A	0x06	0x50	0x04	0x00 0xC2 0x01 0x00	0xDB

Read out the UART\_Baudrate as 0x00 0x01 0xC2 0x00 (115200) Baud.

**7.6.3. CMD\_FACTORY\_RESET\_REQ**

This command restores the default user settings of the module. If this was successful, a software reset of the module is executed additionally. The reset is performed after the acknowledgement is transmitted.

Format:

Start signal	Command	Length	CS
0x02	0x12	0x00	0x10

Response CMD\_FACTORY\_RESET\_CNF:

Start signal	Command   0x40	Length	Status	CS
0x02	0x52	0x01	1 Byte	1 Byte

**Status:**

**0x00:** Request successfully received and processed

**0x01:** Request not successful



## 8. UserSettings - Module configuration values

### 8.1. Difference between volatile and non-volatile settings

The so-called UserSettings are stored permanently into the internal flash of the module. At start-up, these UserSettings are loaded as start values into the volatile settings ("RuntimeSettings"). Some of the RuntimeSettings can be modified by special commands (see chapter 7.5). These RuntimeSettings are lost and replaced by the UserSettings content when the module is restarted.



See chapters 7.5 and 7.6 for methods to change volatile and/or non-volatile settings.

The non-volatile UserSettings can be modified by means of specific commands in the configuration mode (CMD\_SET\_REQ) of the module. These parameters are stored permanently in the module's flash memory. All settings are described on the following pages. After changing those parameters, a reset will be necessary to make use of the new settings.



The validity of the specified parameters given with a CMD\_SET\_REQ is not verified. Incorrect values can result in device malfunction and may even result in the need of re-flashing the entire module firmware!

### 8.2. Modifying the UserSettings

The following chapters will give examples for the modification for many parameters using the commands CMD\_SET\_REQ and CMD\_GET\_REQ. The PC software ACC (version 3.4.3 or newer) can also be used to change non-volatile parameters.

All multiple byte parameters shall be used LSB first if not noted otherwise in the parameter specific section.

Designation	Summary	Permissible values	Default value	Memory position	Length
UART_PktMode	Selects the packet generation method	0, 1	0	5	1
UART_PktSize	Number of characters for transmission start with set packet size	1 - 128	128	7	1
UART_RTSLimit	Number of received characters after which /RTS responds	1 - 128	112	8	1

UART_ETXChar	End-of-text character used to mark data packets, reception of this character triggers wireless transmission	0 - 255	10	9	1
UART_Timeout	Timeout after the last character before the data received via UART are transmitted via wireless transmission [ms]	2 - 65535	5	12	2
UART_DIDelay	Delay between signal by pin /DATA_INDICATION and beginning of output by UART [ms]	0 - 65535	0	14	2
MAC_NumRetrys	Number of wireless retries	0 - 255	0	20	1
MAC_AddrMode	Addressing mode to be used	0 - 2	0	21	1
MAC_NumRetrysCCA	Number of wireless retries for the CCA	0 - 255	5	22	1
MAC_CCARetryDelay	Delay for the retry of the CCA	5 - 255	20	23	1
MAC_DefaultDestNetID	Default destination network ID	0 - 255	0	24	1
MAC_DefaultDestAddrLSB	Default destination address	0 - 255	0	25	1
MAC_DefaultSourceNetID	Own/Local network ID	0 - 254	0	28	1
MAC_DefaultSourceAddrLSB	Own/Local address	0 - 254	0	29	1
MAC_ACKTimeout	Waiting time for wireless acknowledgement [ms]	5 - 65535	10	32	2
PHY_PAPower	Output power [dBm], value range depends on RF configuration complement on two	-11 - 15	2	41	1
PHY_DefaultChannel	Utilized wireless channel after reset, value range depends on RF configuration	201 - 251	226	42	1
PHY_CCAThr	Threshold used for CCA complement on two	0 - 102	22	42	1
OpMode	Operating mode	0, 16	0	60	1
CfgFlags	Flags for setting various properties see chapter 8.22	0 - 65535	512	72	2

RpFlags	Flags to set the repeater options	0 - 65535	0	74	2
RP_NumSlots	Number of (time) slots for packet repetition	0 - 255	32	76	1
UART_Baudrate	Symbol rate of the UART	1200 - 115200	9600	80	4
UART_Databits	Number of data bits	7, 8	8	84	1
UART_Parity	Parity	0 - 2	0	85	1
UART_Stopbits	Stop bits	1, 2	1	86	1
RF_ConfigIndex	Configuration index	3 - 4	3	92	1
RF_CCADisabled	Clear channel assessment	0, 1	1	93	1
RF_CCACheckTime	Observation time for CCA [ms]	0 - 60000	5	94	2

Table 11: Overview of non-volatile user-settings

### 8.3. UART\_PktMode

Designation	Summary	Permissible values	Default value	Memory position	Length
UART_PktMode	Selects the packet generation method	0, 1	0	5	1

Selects the packet mode used for generating packets for the transparent operating mode. In command mode the packet end is defined by the length information in the packet header. Only used in OpMode = transparent.

Two modes have been implemented:

**Mode 0:** Transmission starts when the timeout defined with UART\_Timeout has been reached or the packet has reached size UART\_PktSize.

**Mode 1:** Transmission starts when the character defined with UART\_ETXChar has been detected or the packet has reached size UART\_PktSize .The UART\_ETXChar will be sent too.

#### 8.3.1. Example 1:

Set the parameter UART\_PktMode to 0 (which means the transmission starts when the defined packet size or timeout has been reached).

Command:

Start signal	Command	Length + 2	Memory Position	Length	Parameter	CS
0x02	0x09	0x03	0x05	0x01	0x00	0x0C

Response:

Start signal	Command   0x40	Length	Status	CS
0x02	0x49	0x01	0x00	0x4A

Request successfully received and processed

### 8.3.2. Example 2:

Read the `UART_PktMode` from memory position 5 and length 1.

Command:

Start signal	Command	Length	Memory Position	Amount of Bytes	CS
0x02	0x0A	0x02	0x05	0x01	0x0E

Response:

Start signal	Command   0x40	Length + 2	Memory Position	Length	Parameter	CS
0x02	0x4A	0x03	0x05	0x01	0x00	0x4F

Successfully read the value of `UART_PktMode` as 0.

## 8.4. UART\_PktSize

Designation	Summary	Permissible values	Default value	Memory position	Length
UART_PktSize	Number of characters for transmission start with set packet size	1 - 128	128	7	1

Maximum number of bytes after which the wireless transmission of the data received via UART starts. Used in packet mode 0 as well as in packet mode 1. Maximum is 128 due to buffer size.

Not used in command mode.

### 8.4.1. Example 1:

Set the parameter UART\_PktSize to 120 (0x78).

Command:

Start signal	Command	Length + 2	Memory Position	Length	Parameter	CS
0x02	0x09	0x03	0x07	0x01	0x78	0x76

Response:

Start signal	Command   0x40	Length	Status	CS
0x02	0x49	0x01	0x00	0x4A

Request successfully received and processed

### 8.4.2. Example 2:

Read the UART\_PktSize from memory position 7 and length 1.

Command:

Start signal	Command	Length	Memory Position	Amount of Bytes	CS
0x02	0x0A	0x02	0x07	0x01	0x0C

Response:

Start signal	Command   0x40	Length + 2	Memory Position	Length	Parameter	CS
0x02	0x4A	0x03	0x07	0x01	0x80	0xCD

Successfully read the value of UART\_ PktSize as 128 (0x80).

## 8.5. UART\_RTSLimit

Designation	Summary	Permissible values	Default value	Memory position	Length
UART_RTSLimit	Number of received characters after which /RTS responds	1 - 128	112	8	1

Number of bytes after which the host system is prompted to interrupt the data transfer over /RTS. This is necessary, because depending on the host system, an immediate response to the /RTS signal may not take place (UART FIFO).

Not used in command mode.

### 8.5.1. Example 1:

Set the parameter UART\_RTSLimit to 120 (0x78)

Command:

Start signal	Command	Length + 2	Memory Position	Length	Parameter	CS
0x02	0x09	0x03	0x08	0x01	0x78	0x79

Response:

Start signal	Command   0x40	Length	Status	CS
0x02	0x49	0x01	0x00	0x4A

Request successfully received and processed

### 8.5.2. Example 2:

Read the UART\_RTSLimit from memory position 8 and length 1.

Command:

Start signal	Command	Length	Memory Position	Amount of Bytes	CS
0x02	0x0A	0x02	0x08	0x01	0x03

Response:

Start signal	Command   0x40	Length + 2	Memory Position	Length	Parameter	CS
0x02	0x4A	0x03	0x08	0x01	0x70	0x32

Successfully read the value of UART\_RTSLimit as 112 (0x70).

## 8.6. UART\_ETXChar

Designation	Summary	Permissible values	Default value	Memory position	Length
UART_ETXChar	End-of-text character used to mark data packets, reception of this character triggers wireless transmission	0 - 255	10	9	1

End-of-text character that triggers the transmission of the data received via UART. Only used in packet mode 1 and in OpMode = transparent. During the wireless transmission, the ETX character is treated like a normal character.

Not used in the command mode.

### 8.6.1. Example 1:

Set the parameter UART\_ETXChar to 13.

Command:

Start signal	Command	Length + 2	Memory Position	Length	Parameter	CS
0x02	0x09	0x03	0x09	0x01	0x0D	0x0D

Response:

Start signal	Command   0x40	Length	Status	CS
0x02	0x49	0x01	0x00	0x4A

Request successfully received and processed

### 8.6.2. Example 2:

Read the UART\_ETXChar from memory position 9 and length 1.

Command:

Start signal	Command	Length	Memory Position	Amount of Bytes	CS
0x02	0x0A	0x02	0x09	0x01	0x02

Response:

Start signal	Command   0x40	Length + 2	Memory Position	Length	Parameter	CS
0x02	0x4A	0x03	0x09	0x01	0x0A	0x49

Successfully read the value of UART\_ETXChar as 10.

## 8.7. UART\_Timeout

Designation	Summary	Permissible values	Default value	Memory position	Length
UART_Timeout	Timeout for radio send data trigger (after the last received UART character) [ms]	2 - 65535	5	12	2

The timeout defines the delay in milliseconds in transparent mode after the last character has been received by the UART before the wireless transmission starts. Only used in packet mode 0. The value should be chosen appropriate to the UART data rate. Only used in `OpMode = transparent`.

### 8.7.1. Example 1:

Set the parameter `UART_Timeout` to 10.

Command:

Start signal	Command	Length + 2	Memory Position	Length	Parameter	CS
0x02	0x09	0x04	0x0C	0x02	0x0A 0x00	0x0B

Response:

Start signal	Command   0x40	Length	Status	CS
0x02	0x49	0x01	0x00	0x4A

Request successfully received and processed

### 8.7.2. Example 2:

Read the `UART_Timeout` from memory position 12 and length 2.

Command:

Start signal	Command	Length	Memory Position	Amount of Bytes	CS
0x02	0x0A	0x02	0x0C	0x02	0x04

Response:

Start signal	Command   0x40	Length + 2	Memory Position	Length	Parameter	CS
0x02	0x4A	0x04	0x0C	0x02	0x05 0x00	0x47

Successfully read the value of `UART_Timeout` as 5 ms. 5



## 8.8. UART\_DIDelay

Designation	Summary	Permissible values	Default value	Memory position	Length
UART_DIDelay	Delay between signal by pin /DATA_INDICATION and beginning of UART transmission to host [ms]	0 - 65535	0	14	2

This parameter determines the delay in milliseconds between the indication of incoming RF data by the /DATA\_INDICATION pin and the output of the data on UART. This delay can be used to alert a sleeping host system to prepare for the reception of data.

### 8.8.1. Example 1:

Set the parameter UART\_DIDelay to 5.

Command:

Start signal	Command	Length + 2	Memory Position	Length	Parameter	CS
0x02	0x09	0x04	0x0E	0x02	0x05 0x00	0x06

Response:

Start signal	Command   0x40	Length	Status	CS
0x02	0x49	0x01	0x00	0x4A

Request successfully received and processed

### 8.8.2. Example 2:

Read the UART\_DIDelay from memory position 14 and length 2.

Command:

Start signal	Command	Length	Memory Position	Amount of Bytes	CS
0x02	0x0A	0x02	0x0E	0x02	0x06

Response:

Start signal	Command   0x40	Length + 2	Memory Position	Length	Parameter	CS
0x02	0x4A	0x04	0x0E	0x02	0x00 0x00	0x40

Successfully read the value of UART\_DIDelay as 0 ms.

## 8.9. MAC\_NumRetrys

Designation	Summary	Permissible values	Default value	Memory position	Length
MAC_NumRetrys	Number of wireless retries	0 - 255	0	20	1

Determines the maximum number of wireless transmission retries. If this parameter is set to a value other than 0, the receiver module will automatically be prompted to send a wireless acknowledgement ("ACK"). Please note that sending acknowledgements additionally increases the traffic.

According to *ESTI EN 301 391*, the value for MAC\_NumRetrys should be 5 at most.

### 8.9.1. Example 1:

Setting the number of wireless retries to 5 (parameter MAC\_NumRetrys).

Command:

Start signal	Command	Length + 2	Memory Position	Length	Parameter	CS
0x02	0x09	0x03	0x14	0x01	0x05	0x18

Response:

Start signal	Command   0x40	Length	Status	CS
0x02	0x49	0x01	0x00	0x4A

Request successfully received and processed

### 8.9.2. Example 2:

Read the MAC\_NumRetrys from memory position 20 and length 1.

Command:

Start signal	Command	Length	Memory Position	Amount of Bytes	CS
0x02	0x0A	0x02	0x14	0x01	0x1F

Response:

Start signal	Command   0x40	Length + 2	Memory Position	Length	Parameter	CS
0x02	0x4A	0x03	0x14	0x01	0x00	0x5E

Successfully read the value of MAC\_NumRetrys as 0.

## 8.10. MAC\_AddrMode

Designation	Summary	Permissible values	Default value	Memory position	Length
MAC_AddrMode	Addressing mode to use	0 - 2	0	21	1

Addressing mode selection. The following modes have been implemented:

- No addressing (mode 0): Each module receives the transmitted RF telegram and delivers the received data to the host system via UART. No address information is transmitted in the radio telegram.
- 1-byte address (mode 1): The receiving module only delivers the data to the host system via UART if the destination address configured at the sender (MAC\_DefaultDestAddrLSB) corresponds to the source address (MAC\_DefaultSourceAddrLSB) or the destination address 255 (broadcast) was specified. Both the destination address and the source address are transmitted in the wireless telegram (total = 2 bytes).
- 2-bytes address (mode 2): The receiving module only delivers the data to the host system via UART if both the destination network ID and the destination address correspond to the source addresses (MAC\_DefaultSourceNetID and MAC\_DefaultSourceAddrLSB) or the destination address 255 (broadcast) was specified. A total of 4 bytes of address information are transmitted in the wireless telegram.



Caution: In addressing mode 0, the use of wireless acknowledgement may cause problems if several wireless modules are addressed simultaneously. Therefore no ACK is requested when using addressing mode 0.



The receiver and transmitter modules must operate in the same addressing mode! Otherwise the receiver cannot decrypt the data packet sent and thus the packet is discarded!

### 8.10.1. Example 1:

Setting the MAC\_AddrMode to 1.

Command:

Start signal	Command	Length + 2	Memory Position	Length	Parameter	CS
0x02	0x09	0x03	0x15	0x01	0x01	0x1D

Response:

Start signal	Command   0x40	Length	Status	CS
0x02	0x49	0x01	0x00	0x4A

Request successfully received and processed

**8.10.2. Example 2:**

Read the MAC\_AddrMode from memory position 21 and length 1.

Command:

Start signal	Command	Length	Memory Position	Amount of Bytes	CS
0x02	0x0A	0x02	0x15	0x01	0x1E

Response:

Start signal	Command   0x40	Length + 2	Memory Position	Length	Parameter	CS
0x02	0x4A	0x03	0x15	0x01	0x01	0x5E

Successfully read the value of MAC\_AddrMode as 1.

## 8.11. MAC\_NumRetrysCCA

Designation	Summary	Permissible values	Default value	Memory position	Length
MAC_NumRetrysCCA	Number of wireless retries for the CCA	0 - 255	5	22	1

Determines the maximum number of retries, the module is checking for a clear channel before wireless transmission (CCA). The user must adopt all relevant CCA values to the system design and environment.

### 8.11.1. Example 1:

Set the parameter MAC\_NumRetrysCCA to 2.

Command:

Start signal	Command	Length + 2	Memory Position	Length	Parameter	CS
0x02	0x09	0x03	0x16	0x01	0x02	0x1D

Response:

Start signal	Command   0x40	Length	Status	CS
0x02	0x49	0x01	0x00	0x4A

Request successfully received and processed

### 8.11.2. Example 2:

Read the MAC\_NumRetrysCCA from memory position 22 & length 1.

Command:

Start signal	Command	Length	Memory Position	Amount of Bytes	CS
0x02	0x0A	0x02	0x16	0x01	0x1D

Response:

Start signal	Command   0x40	Length + 2	Memory Position	Length	Parameter	CS
0x02	0x4A	0x03	0x16	0x01	0x05	0x59

Successfully read the value of MAC\_NumRetrysCCA as 5.

## 8.12. MAC\_CCARetryDelay

Designation	Summary	Permissible values	Default value	Memory position	Length
MAC_CCARetryDelay	Delay for the retry of the CCA	5 - 255	20	23	1

Determines the delay the module waits for wireless transmission after a busy channel was detected. The user must adopt all relevant CCA values to the system design and environment.

### 8.12.1. Example 1:

Set the parameter MAC\_CCARetryDelay to 50 ms.

Command:

Start signal	Command	Length + 2	Memory Position	Length	Parameter	CS
0x02	0x09	0x03	0x17	0x01	0x32	0x2C

Response:

Start signal	Command   0x40	Length	Status	CS
0x02	0x49	0x01	0x00	0x4A

Request successfully received and processed

### 8.12.2. Example 2:

Read the MAC\_CCARetryDelay from memory position 23 & length 1.

Command:

Start signal	Command	Length	Memory Position	Amount of Bytes	CS
0x02	0x0A	0x02	0x17	0x01	0x1C

Response:

Start signal	Command   0x40	Length + 2	Memory Position	Length	Parameter	CS
0x02	0x4A	0x03	0x17	0x01	0x14	0x49

Successfully read the value of MAC\_CCARetryDelay as 20 ms.

### 8.13. MAC\_DefaultDestNetID

Designation	Summary	Permissible values	Default value	Memory position	Length
MAC_DefaultDestNetID	Default destination network ID	0 - 255	0	24	1

Destination network address which is used in addressing mode 2. Can be modified with the command CMD\_SET\_DESTNETID\_REQ at runtime (volatile). If the special broadcast ID and the broadcast address are set to 255, the packets will be received by all network participants.

#### 8.13.1. Example 1:

Set the parameter MAC\_DefaultDestNetID to 1.

Command:

Start signal	Command	Length + 2	Memory Position	Length	Parameter	CS
0x02	0x09	0x03	0x18	0x01	0x01	0x10

Response:

Start signal	Command   0x40	Length	Status	CS
0x02	0x49	0x01	0x00	0x4A

Request successfully received and processed

#### 8.13.2. Example 2:

Read MAC\_DefaultDestNetID from memory position 24, length 1.

Command:

Start signal	Command	Length	Memory Position	Amount of Bytes	CS
0x02	0x0A	0x02	0x18	0x01	0x13

Response:

Start signal	Command   0x40	Length + 2	Memory Position	Length	Parameter	CS
0x02	0x4A	0x03	0x18	0x01	0x00	0x52

Successfully read the value of MAC\_DefaultDestNetID as 0.

## 8.14. MAC\_DefaultDestAddrLSB

Designation	Summary	Permissible values	Default value	Memory position	Length
MAC_DefaultDestAddrLSB	Default destination address (LSB)	0 - 255	0	25	1

Least significant byte of the destination address which is used in addressing modes 1 and 2. Can be modified with the command `CMD_SET_DESTADDR_REQ` at runtime (volatile). If the special broadcast address 255 is used (in the case of addressing mode 2, broadcast ID is also 255), the packets will be received by all network participants.

### 8.14.1. Example 1:

Set the parameter `MAC_DefaultDestAddrLSB` to 1.

Command:

Start signal	Command	Length + 2	Memory Position	Length	Parameter	CS
0x02	0x09	0x03	0x19	0x01	0x01	0x11

Response:

Start signal	Command   0x40	Length	Status	CS
0x02	0x49	0x01	0x00	0x4A

Request successfully received and processed

### 8.14.2. Example 2:

Read the `MAC_DefaultDestNetID` from memory position 24 and length 1.

Command:

Start signal	Command	Length	Memory Position	Amount of Bytes	CS
0x02	0x0A	0x02	0x18	0x01	0x13

Response:

Start signal	Command   0x40	Length + 2	Memory Position	Length	Parameter	CS
0x02	0x4A	0x03	0x18	0x01	0x00	0x52

Successfully read the value of `MAC_DefaultDestNetID` as 0.



## 8.15. MAC\_DefaultSourceNetID

Designation	Summary	Permissible values	Default value	Memory position	Length
MAC_DefaultSourceNetID	Own/Local network ID	0 - 254	0	28	1

Source network ID to be used in addressing mode 2.

### 8.15.1. Example 1:

Set the parameter MAC\_DefaultDestNetID to 1.

Command:

Start signal	Command	Length + 2	Memory Position	Length	Parameter	CS
0x02	0x09	0x03	0x1C	0x01	0x01	0x14

Response:

Start signal	Command   0x40	Length	Status	CS
0x02	0x49	0x01	0x00	0x4A

Request successfully received and processed

### 8.15.2. Example 2:

Read the MAC\_DefaultSourceNetID from memory position 28, length 1.

Command:

Start signal	Command	Length	Memory Position	Amount of Bytes	CS
0x02	0x0A	0x02	0x1C	0x01	0x17

Response:

Start signal	Command   0x40	Length + 2	Memory Position	Length	Parameter	CS
0x02	0x4A	0x03	0x1C	0x01	0x00	0x56

Successfully read the value of MAC\_DefaultSourceNetID as 0.

## 8.16. MAC\_DefaultSourceAddrLSB

Designation	Summary	Permissible values	Default value	Memory position	Length
MAC_DefaultSourceAddrLSB	Own/Local address (LSB)	0 - 254	0	29	1

Source device address to be used in addressing modes 1 and 2.

### 8.16.1. Example 1:

Set the parameter MAC\_DefaultSourceAddrLSB to 1.

Command:

Start signal	Command	Length + 2	Memory Position	Length	Parameter	CS
0x02	0x09	0x03	0x1D	0x01	0x01	0x15

Response:

Start signal	Command   0x40	Length	Status	CS
0x02	0x49	0x01	0x00	0x4A

Request successfully received and processed

### 8.16.2. Example 2:

Read MAC\_DefaultSourceAddrLSB from memory position 29, length 1.

Command:

Start signal	Command	Length	Memory Position	Amount of Bytes	CS
0x02	0x0A	0x02	0x1D	0x01	0x16

Response:

Start signal	Command   0x40	Length + 2	Memory Position	Length	Parameter	CS
0x02	0x4A	0x03	0x1D	0x01	0x00	0x57

Successfully read the value of MAC\_DefaultSourceAddrLSB as 0.

## 8.17. MAC\_ACKTimeout

Designation	Summary	Permissible values	Default value	Memory position	Length
MAC_ACKTimeout	Waiting time for wireless acknowledgement [ms]	5 - 65535	10	32	2

Time to wait for a RF acknowledgement before a RF retry is triggered.

### 8.17.1. Example 1:

Set the parameter MAC\_ACKTimeout to 15.

Command:

Start signal	Command	Length + 2	Memory Position	Length	Parameter	CS
0x02	0x09	0x04	0x20	0x02	0x0F 0x00	0x22

Response:

Start signal	Command   0x40	Length	Status	CS
0x02	0x49	0x01	0x00	0x4A

Request successfully received and processed.

### 8.17.2. Example 2:

Read the MAC\_ACKTimeout from memory position 32 and length 2.

Command:

Start signal	Command	Length	Memory Position	Amount of Bytes	CS
0x02	0x0A	0x02	0x20	0x02	0x28

Response:

Start signal	Command   0x40	Length + 2	Memory Position	Length	Parameter	CS
0x02	0x4A	0x04	0x20	0x02	0x0A 0x00	0x64

Successfully read the value of MAC\_ACKTimeout as 10 ms.

## 8.18. PHY\_PAPower

Designation	Summary	Permissible values	Default value	Memory position	Length
PHY_PAPower	Output power [dBm], value range depends on RF configuration complement on two	-11 - 15	2	41	1

Parameter for the RF output power of the module. The maximum permissible output depends on the used RF configurations.

The RF chip only supports discrete values. Mapping to the next possible PHY\_PAPower value is done by the module. The next smaller PHY\_PAPower value is always chosen when the transferred value is not possible. The step distance equals 1 dB.

The Usersettings PHY\_PAPower is entered as a complement on two.



The statutory regulations for the maximum power output have to be adhered to.

### 8.18.1. Example 1:

Using the value 15 dBm with parameter PHY\_PAPower.

Command:

Start signal	Command	Length + 2	Memory Position	Length	Parameter	CS
0x02	0x09	0x03	0x29	0x01	0x0F	0x2F

Response:

Start signal	Command   0x40	Length	Status	CS
0x02	0x49	0x01	0x00	0x4A

Request successfully received and processed

### 8.18.2. Example 2:

Read the PHY\_PAPower from memory position 41 and length 1.

Command:

Start signal	Command	Length	Memory Position	Amount of Bytes	CS
0x02	0x0A	0x02	0x29	0x01	0x22

Response:

Start signal	Command   0x40	Length + 2	Memory Position	Length	Parameter	CS
0x02	0x4A	0x03	0x29	0x01	0x0F	0x6C

Successfully read the value of PHY\_PAPower as 15 dBm.

## 8.19. PHY\_DefaultChannel

Designation	Summary	Permissible values	Default value	Memory position	Length
PHY_DefaultChannel	Utilized wireless channel after reset, value range depends on RF configuration	201 - 251	226	42	1

Determines the wireless channel of the module to be used after a reset.

$$PHYDefaultChannel = \frac{Frequency_{RF} - 802.000MHz}{0.500MHz} \quad (1)$$

### 8.19.1. Example 1:

Using the channel 100 as PHY\_DefaultChannel.

Command:

Start signal	Command	Length + 2	Memory Position	Length	Parameter	CS
0x02	0x09	0x03	0x2A	0x01	0x64	0x47

Response:

Start signal	Command   0x40	Length	Status	CS
0x02	0x49	0x01	0x00	0x4A

Request successfully received and processed.

### 8.19.2. Example 2:

Read the PHY\_DefaultChannel from memory position 42 and length 1.

Command:

Start signal	Command	Length	Memory Position	Amount of Bytes	CS
0x02	0x0A	0x02	0x2A	0x01	0x21

Response:

Start signal	Command   0x40	Length + 2	Memory Position	Length	Parameter	CS
0x02	0x4A	0x03	0x2A	0x01	0x64	0x04

Successfully read the value of PHY\_DefaultChannel as 100.

## 8.20. PHY\_CCAThr

Designation	Summary	Permissible values	Default value	Memory position	Length
PHY_CCAThr CCA threshold	Threshold used for CCA complement on two	0 - 102	22	42	1

This parameter sets the threshold at which a signal is considered as such. The user must adopt all relevant CCA values to the system design and environment. The calculation for the user settings is as follow:

$$\text{Threshold}_{dBm} = \text{PHY\_CCAThr} - 102 \text{ dBm}$$

### 8.20.1. Example 1:

Using the value 25 (which means -87dBm) as PHY\_CCAThr.

Command:

Start signal	Command	Length + 2	Memory Position	Length	Parameter	CS
0x02	0x09	0x03	0x2B	0x01	0x19	0x3B

Response:

Start signal	Command   0x40	Length	Status	CS
0x02	0x49	0x01	0x00	0x4A

Request successfully received and processed.

### 8.20.2. Example 2:

Read the PHY\_CCAThr from memory position 43 and length 1.

Command:

Start signal	Command	Length	Memory Position	Amount of Bytes	CS
0x02	0x0A	0x02	0x2B	0x01	0x20

Response:

Start signal	Command   0x40	Length + 2	Memory Position	Length	Parameter	CS
0x02	0x4A	0x03	0x2B	0x01	0x16	0x77

Successfully read the value of PHY\_CCAThr as 22 (which means -80 dBm).

## 8.21. OpMode

Designation	Summary	Permissible values	Default value	Memory position	Length
OpMode	Operating mode	0, 16	0	60	1

Choose between operating modes. Can be selected between mode 0 (transparent data transfer) and mode 16 (command mode).

### 8.21.1. Example 1:

Set the parameter OpMode to 16 (command mode).

Command:

Start signal	Command	Length + 2	Memory Position	Length	Parameter	CS
0x02	0x09	0x03	0x3C	0x01	0x10	0x25

Response:

Start signal	Command   0x40	Length	Status	CS
0x02	0x49	0x01	0x00	0x4A

Request successfully received and processed

### 8.21.2. Example 2:

Read the OpMode from memory position 60 and length 1.

Command:

Start signal	Command	Length	Memory Position	Amount of Bytes	CS
0x02	0x0A	0x02	0x3C	0x01	0x37

Response:

Start signal	Command   0x40	Length + 2	Memory Position	Length	Parameter	CS
0x02	0x4A	0x03	0x3C	0x01	0x00	0x76

Successfully read the value of OpMode as 0 (transparent mode).



## 8.22. CfgFlags

Designation	Summary	Permissible values	Default value	Memory position	Length
CfgFlags	Flags for setting various properties see chapter 8.22	0 - 65535	512	72	2

16-bit field in which the use of individual pins or signals can be disabled. Table 12 represents a description of the respective flags.

To use multiple settings, add the bit numbers and choose the result as value for CfgFlags.

By default, CfgFlags for modules are 0x0200 (LED's enabled). For the USB-Sticks the default CfgFlags are 0x021F (LED's enabled, *Config*, *Data\_Request* & *TRX\_Disable* pins disabled).

Bit no.	Description
0 (0x0001)	Setting this bit disables the <i>/CONFIG</i> pin. Thus the unit can no longer be switched to the command mode via this pin.
1 (0x0002)	Setting this bit disables the <i>/DATA_REQUEST</i> pin.
2 (0x0004)	Reserved
3 (0x0008)	Setting this bit, disables handling of the status of the <i>TRX_DISABLE</i> pin. Hence, the module can no longer be set to the various power-saving modes via this pin.
4 (0x0010)	Setting this bit, enables a different behavior of the <i>TRX_DISABLE</i> pin. If this bit is set and the <i>TRX_DISABLE</i> pin is set, then additionally to the RF-chip, the UART is powered down. In this case, furthermore the chip is powered down to LPM3 and the <i>CONFIG</i> pin is disabled. The needed wakeup time after releasing the <i>TRX_DISABLE</i> pin is < 1ms.
5 (0x0020)	Any character will be accepted as valid checksum in the command mode if this bit is set.
6 (0x0040)	Setting this bit, disables the pull down of the pin <i>TRX_DISABLE</i> .
7 (0x0080)	The address will not be resolved if this bit is set. The particular module can be used as packet sniffer to monitor a wireless link. No ACK is sent.
8 (0x0100)	Setting this bit enables the <i>/CTS</i> flow control pin.
9 (0x0200)	Setting this bit enables the outputs for RF activity, (e.g. for LEDs).
10 to 15	Reserved

Table 12: Configuration flags



Warning: If both bit 0 and bit 2 are set, the module can no longer be set to the command mode.



This parameter set consisting of two bytes has to be transferred LSB first. That means, first the byte with bits 0 ... 7, then the byte with bits 8 ... 15.

**8.22.1. Example 1:**

Set the `CfgFlags` to 0.

Command:

Start signal	Command	Length + 2	Memory Position	Length	Parameter	CS
0x02	0x09	0x04	0x48	0x02	0x00 0x00	0x45

Response:

Start signal	Command   0x40	Length	Status	CS
0x02	0x49	0x01	0x00	0x4A

Request successfully received and processed

**8.22.2. Example 2:**

Read the `CfgFlags` from memory position 72 and length 2.

Command:

Start signal	Command	Length	Memory Position	Amount of Bytes	CS
0x02	0x0A	0x02	0x48	0x02	0x40

Response:

Start signal	Command   0x40	Length + 2	Memory Position	Length	Parameter	CS
0x02	0x4A	0x04	0x48	0x02	0x00 0x02	0x04

Successfully read the value of `CfgFlags` as 512 (LEDs are enabled).

## 8.23. RpFlags

Designation	Summary	Permissible values	Default value	Memory position	Length
RpFlags Repeater configuration flags (hex.)	Flags to set the repeater options	0 - 65535	0	74	2

16-bit field contains the settings of the repeater functionality. Table 12 represents a description of the respective flags. To use multiple settings, add the bit numbers and choose the result as value for RpFlags.



On RF\_ConfigIndex = 1 the RpFlags must be kept at the default value of 0x0000.



All repeated frames must be taken into account for the duty cycle calculation of the module.

By default, RpFlags is 0x0000.

Bit no.	Description
0 (0x0001)	Setting this bit enables the repeater function, see chapter 11
1 to 15	Reserved

Table 13: Repeater configuration flags

### 8.23.1. Example 1:

Set the parameter RpFlags to 1 (which means the repeater function is enabled).

Command:

Start signal	Command	Length + 2	Memory Position	Length	Parameter	CS
0x02	0x09	0x04	0x4A	0x02	0x01 0x00	0x46

Response:

Start signal	Command   0x40	Length	Status	CS
0x02	0x49	0x01	0x00	0x4A

Request successfully received and processed.

**8.23.2. Example 2:**

Read the RpFlags from memory position 74 and length 2.

Command:

Start signal	Command	Length	Memory Position	Amount of Bytes	CS
0x02	0x0A	0x02	0x4A	0x02	0x42

Response:

Start signal	Command   0x40	Length + 2	Memory Position	Length	Parameter	CS
0x02	0x4A	0x04	0x4A	0x02	0x01 0x00	0x05

Successfully read the value of RpFlags as 1 (Repeater is enabled).

## 8.24. RP\_NumSlots

Designation	Summary	Permissible values	Default value	Memory position	Length
RP_NumSlots	Number of (time) slots for packet repetition	0 - 255	32	76	1

An 8 bit field that contains the number of time slots to be used for the packet repetition.

When using several repeater devices in a single network, repeated data packets can collide in the frequency channel, when all repeater devices send the received packet at the same time. To avoid this, the frequency channel is divided in RP\_NumSlots time slots, where each repeater chooses a certain slot by random.

The smallest number of time slots that is needed, depends on the network structure and the number of the repeaters used. When there are NumRP repeater devices in the range of a sending device, the probability that two repeated packets collide can be calculated by:

$$1 - \frac{RP\_NumSlots!}{RP\_NumSlots^{NumRP} [RP\_NumSlots - NumRP]!}$$

Common values are:

NumRP	RP_NumSlots	Collision probability
2	32	3.1%
3	32	9.2%
4	32	17.7%
5	64	14.8%
6	64	21.5%
7	128	15.4%

Table 14: Common settings of RP\_NumSlots

In the example network shown in Figure 4, there are only two repeater that can conflict each other. Repeater 2 and 3 are forwarding the packet received from Sender 1 "at the same time". Thus NumRP equals 2 and RP\_NumSlots equal 32 is sufficient.

The time delay used by the repeater device can determined as the time needed to send one packet (see chapter 8.28) times a random number between 1 and RP\_NumSlots.

Example: In RF\_ConfigIndex 0 the maximum send time for one packet is about 40ms. If we now use 32 RP\_NumSlots, the packet is forwarded latest after 32 × 40ms = 1280ms.

**8.24.1. Example 1:**

Set the `RP_NumSlots` to 64.

Command:

Start signal	Command	Length + 2	Memory Position	Length	Parameter	CS
0x02	0x09	0x03	0x4C	0x01	0x40	0x05

Response:

Start signal	Command   0x40	Length	Status	CS
0x02	0x49	0x01	0x00	0x4A

Request successfully received and processed

**8.24.2. Example 2:**

Read the `RP_NumSlots` from memory position 76 and length 1.

Command:

Start signal	Command	Length	Memory Position	Amount of Bytes	CS
0x02	0x0A	0x02	0x4C	0x01	0x47

Response:

Start signal	Command   0x40	Length + 2	Memory Position	Length	Parameter	CS
0x02	0x4A	0x03	0x4C	0x01	0x40	0x46

Successfully read the value of `RP_NumSlots` as 64.

**8.24.3. UART\_Baudrate: Configure the UART speed**

Designation	Summary	Permissible values	Default value	Memory position	Length
UART_Baudrate	Symbol rate of the UART	1200 - 115200	9600	80	4

A 32 bit field, that contains the symbol rate for the communication interface (in LSB first notation). Symbol rates up to 115200 Baud are supported. Default symbol rate is 9600 Baud. Please note that for baud rates higher than 9600 Baud the LPM has a higher energy consumption.

**8.24.4. Example 1:**

Set the UART\_Baudrate to 115200 Baud. Take decimal 115200, convert it to MSB first hex notation 0x0001c200 and then apply the LSB first byte order: 0x00C20100.

Command:

Start signal	Command	Length + 2	Memory position	Length	Parameter	CS
0x02	0x09	0x06	0x50	0x04	0x00 0xC2 0x01 0x00	0x9A

Response:

Start signal	Command   0x40	Length	Status	CS
0x02	0x49	0x01	0x00	0x4A

Request successfully received and processed.

**8.24.5. Example 2:**

Read the UART\_Baudrate from memory position 80 and length 4.

Command:

Start signal	Command	Length	Memory Position	Amount of Bytes	CS
0x02	0x0A	0x02	0x50	0x04	0x5E

Response:

Start signal	Command   0x40	Length + 2	Memory position	Length	Parameter	CS
0x02	0x4A	0x06	0x50	0x04	0x00 0xC2 0x01 0x00	0xD9

Successfully read the value of UART\_Baudrate as 115200 Baud.



## 8.25. UART\_Databits

Designation	Summary	Permissible values	Default value	Memory position	Length
UART_Databits	Number of data bits	7, 8	8	84	1

An 8 bit field that contains the number of data bits on the communication interface. Supported values are 7 and 8.



It is highly recommended to use 8 databits.

### 8.25.1. Example 1:

Set the parameter UART\_Databits to 8.

Command:

Start signal	Command	Length + 2	Memory Position	Length	Parameter	CS
0x02	0x09	0x03	0x54	0x01	0x08	0x55

Response:

Start signal	Command   0x40	Length	Status	CS
0x02	0x49	0x01	0x00	0x4A

Request successfully received and processed

### 8.25.2. Example 2:

Read the UART\_Databits from memory position 84 and length 1.

Command:

Start signal	Command	Length	Memory Position	Amount of Bytes	CS
0x02	0x0A	0x02	0x54	0x01	0x5F

Response:

Start signal	Command   0x40	Length + 2	Memory Position	Length	Parameter	CS
0x02	0x4A	0x03	0x54	0x01	0x08	0x16

Successfully read the value of UART\_Databits as 8.

## 8.26. UART\_Parity

Designation	Summary	Permissible values	Default value	Memory position	Length
UART_Parity	Parity	0, 1, 2	0	85	1

Parity mode	UART_Parity value
'n' no parity	0
'e' even parity	1
'o' odd parity	2

An 8 bit field that contains the parity mode for the communication interface.

### 8.26.1. Example 1:

Set the parameter UART\_Parity to 0 (no parity).

Command:

Start signal	Command	Length + 2	Memory Position	Length	Parameter	CS
0x02	0x09	0x03	0x55	0x01	0x00	0x5C

Response:

Start signal	Command   0x40	Length	Status	CS
0x02	0x49	0x01	0x00	0x4A

Request successfully received and processed

### 8.26.2. Example 2:

Read the UART\_Parity from memory position 85 and length 1.

Command:

Start signal	Command	Length	Memory Position	Amount of Bytes	CS
0x02	0x0A	0x02	0x55	0x01	0x5E

Response:

Start signal	Command   0x40	Length + 2	Memory Position	Length	Parameter	CS
0x02	0x4A	0x03	0x55	0x01	0x00	0x1F

Successfully read the value of UART\_Parity as 0 ('n' no parity).

## 8.27. UART\_Stoppbits

Designation	Summary	Permissible values	Default value	Memory position	Length
UART_Stoppbits	Stop bits	1, 2	1	86	1

An 8 bit field that contains the number of stop bits for the communication interface. Supported are 1 and 2 stop bits.



It is highly recommended to use 1 stop bit.

### 8.27.1. Example 1:

Set the parameter UART\_Stoppbits to 1.

Command:

Start signal	Command	Length + 2	Memory Position	Length	Parameter	CS
0x02	0x09	0x03	0x56	0x01	0x01	0x5E

Response:

Start signal	Command   0x40	Length	Status	CS
0x02	0x49	0x01	0x00	0x4A

Request successfully received and processed

### 8.27.2. Example 2:

Read the UART\_Stoppbits from memory position 86 and length 1.

Command:

Start signal	Command	Length	Memory Position	Amount of Bytes	CS
0x02	0x0A	0x02	0x56	0x01	0x5D

Response:

Start signal	Command   0x40	Length + 2	Memory Position	Length	Parameter	CS
0x02	0x4A	0x03	0x56	0x01	0x01	0x1D

Successfully read the value of UART\_Stoppbits as 1.

## 8.28. RF\_ConfigIndex

Designation	Summary	Permissible values	Default value	Memory position	Length
RF_ConfigIndex	Radio profile index	3, 4	3	92	1

An 8 bit field that addresses the applied RF configuration, also called radio profile.

Profile	Data rate (gross) [kcps]	Modulation	Max packet time for repeater mode [ms]
3	38.4	GFSK	40
4	100	GFSK	20

Table 15: radio profiles

### 8.28.1. Example 1:

Set the RF\_ConfigIndex to 4.

Command:

Startsignal	Command	Length + 2	Memory Position	Length	Parameter	CS
0x02	0x09	0x03	0x5C	0x01	0x04	0x51

Response:

Startsignal	Command   0x40	Length	Status	CS
0x02	0x49	0x01	0x00	0x4A

Request successfully received and processed

### 8.28.2. Example 2:

Read the RF\_ConfigIndex from memory position 92 and length 1.

Command:

Startsignal	Command	Length	MemoryPosition	Amount of Bytes	CS
0x02	0x0A	0x02	0x5C	0x01	0x57

Response:

Startsignal	Command  0x40	Length + 2	MemoryPosition	Length	Parameter	CS
0x02	0x4A	0x03	0x5C	0x01	0x03	0x15

Successfully read the value of RF\_ConfigIndex as 3.

## 8.29. RF\_CCADisabled



Due to backwards compatibility this CCA method is not suited for being used as Polite Spectrum Access (PSA) as introduced by Norms of the European Radio Equipment Directive (RED). If you need PSA in your system a customer specific firmware is required.

Designation	Summary	Permissible values	Default value	Memory position	Length
RF_CCADisabled	Clear channel assessment	0, 1	1	93	1

An 8 bit field that disables the channel access via clear channel assessment. The default value is 1 and means CCA is disabled.

When enabled each CCA parameter must be adopted to the customer's end system and environment.

### 8.29.1. Example 1:

Set the parameter RF\_CCADisabled to 0 (i.e. CCA is enabled).

Command:

Start signal	Command	Length + 2	Memory Position	Length	Parameter	CS
0x02	0x09	0x03	0x5D	0x01	0x00	0x54

Response:

Start signal	Command   0x40	Length	Status	CS
0x02	0x49	0x01	0x00	0x4A

Request successfully received and processed

### 8.29.2. Example 2:

Read the parameter RF\_CCADisabled from memory position 93 and length 1.

Command:

Start signal	Command	Length	Memory Position	Amount of Bytes	CS
0x02	0x0A	0x02	0x5D	0x01	0x56

Response:

Start signal	Command   0x40	Length + 2	Memory Position	Length	Parameter	CS
0x02	0x4A	0x03	0x5D	0x01	0x00	0x17

Successfully read the value of RF\_CCADisabled as 0 (which means CCA is enabled).



### 8.30. RF\_CCACheckTime

Designation	Summary	Permissible values	Default value	Memory position	Length
RF_CCACheckTime	Observation time [ms]	0 - 60000	5	94	2

A 16 bit field that contains the time in milliseconds for which the channel with activated CCA has to be observed and identified as free before channel access can take place.

#### 8.30.1. Example 1:

Set the RF\_CCACheckTime to 10ms.

Command:

Start signal	Command	Length + 2	Memory Position	Length	Parameter	CS
0x02	0x09	0x04	0x5E	0x02	0x0A 0x00	0x59

Response:

Start signal	Command   0x40	Length	Status	CS
0x02	0x49	0x01	0x00	0x4A

Request successfully received and processed.

#### 8.30.2. Example 2:

Read the RF\_CCACheckTime from memory position 94 and length 2.

Command:

Start signal	Command	Length	Memory Position	Amount of Bytes	CS
0x02	0x0A	0x02	0x5E	0x02	0x56

Response:

Start signal	Command   0x40	Length + 2	Memory Position	Length	Parameter	CS
0x02	0x4A	0x04	0x5E	0x02	0x05 0x00	0x15

Successfully read the value of RF\_CCACheckTime as 5 ms.

## 9. Timing parameters

### 9.1. Reset behavior

Following a reset, a stable (>5ms) LOW on the */RTS* pin signals that the module is ready for operation. This level is however only valid, after the delay required for the internal initialization of the processor (a few  $\mu$ s).

#### 9.1.1. Power-on reset

Hold the */RESET* LOW. After applying the supply voltage, waiting till the supply voltage level is stable and releasing the */RESET* pin to HIGH, the time until the module is ready for operation can last up to 1s. And will be indicated by a stable (>5ms) LOW level of the */RTS* module signal.

#### 9.1.2. Reset via */RESET* pin

To force a module restart by means of the */RESET* pin, it must first be drawn to LOW for at least 10 ms before a rising edge will trigger a module restart.

After the pin is released, */RTS* will switch to high after 100  $\mu$ s at the latest. Since the start-up time for the clock quartz does not apply in this case, the time until the module is ready for operation is reduced to a couple of ms. During this time, the processor clock-rate will be calibrated, which takes anyway between 2 and 20 ms depending on the supply voltage and temperature.

Recommended procedure:

After the */RESET* pin is released, wait for the stable LOW level on the */RTS* pin. Subsequently, additional 100  $\mu$ s are required until the system is ready.

#### 9.1.3. Reset as result of a serious error condition

If the module runs in a serious error condition, a software reset is executed. In this case, the module starts up automatically and can be used again. The volatile runtime settings are reset to default, see chapter 7.

### 9.2. Latencies when leaving the LPM

The module enters a LPM as soon as no data-transmission request is received via serial and RF interface.

If the device returns from such a mode, all internal settings like the channel calibration values and noise levels have been retained, such that the module is ready after a few  $\mu$ s. Also here a low signal at the */RTS* indicates that the module is ready for operation.

### **9.3. Latencies during data transfer / packet generation**

The data transfer is always buffered, i.e. data received via UART is buffered in the module until a specific event occurs. Subsequently, the UART reception is interrupted (flow control with /RTS signal), and the payload data is passed to the internal memory of the wireless transceiver (FIFO).

The optional channel access method (CCA) adds additional latency. This can be configured in the user settings. The default access method (ALOHA) does not add additional latency.

The wireless transmission starts as soon as the first data is available in the transceiver memory. During the continuous wireless transmission the remaining payload data is transmitted byte by byte.

On the receiver side, the FIFO is read as soon as an incoming packet is detected.

If the module detects a packet that requires an ACK, the ACK is sent directly after the packet reception. The channel access method is always deactivated for ACKs.

In combination with a suitable packet generation method, this procedure enables the minimisation of the latencies resulting from buffering.

According to ETSI EN Norms the time for one packet (including the respective acknowledge) should not exceed 100 ms. For slow data rates the packet size has to be reduced respectively by the user.

## 10. Radio parameters

The RF parameters are configured with the `RF_ConfigIndex` as well as with `PHY_DefaultChannel` and `PHY_PAPower`.

Furthermore, the volatile runtime parameters can be configured over the respective command during runtime. This leads to the adoption of these parameters with the next packet transmit or receive.



To reference the modules FCC ID it must be used a permanently attached antenna or an antenna that uses an unique coupling with an antenna gain below 2 dBi.

The default configuration consists of a data rate of 38.4 kcps (`RF_ConfigIndex = 3`), a frequency of 915.00 MHz (`PHY_DefaultChannel = 226`) and a value of 2 for `PHY_PAPower`.

### 10.1. Channel assignment

Red marked channels are not to be selected by the user configuration. The FCC & IC Frequency band ranges from 902.00 to 928.00 MHz. The available channel spacing is 500kHz.

Channel	Frequency MHz	Profile 3	Profile 4	Channel	Frequency [MHz]	Profile 3	Profile 4
200	902.00			226	915.00		
201	902.50			227	915.50		
202	903.00			228	916.00		
203	903.50			229	916.50		
204	904.00			230	917.00		
205	904.50			231	917.50		
206	905.00			232	918.00		
207	905.50			233	918.50		
208	906.00			234	919.00		
209	906.50			235	919.50		
210	907.00			236	920.00		
211	907.50			237	920.50		
212	908.00			238	921.00		
213	908.50			239	921.50		
214	909.00			240	922.00		
215	909.50			241	922.50		
216	910.00			242	923.00		
217	910.50			243	923.50		
218	911.00			244	924.00		
219	911.50			245	924.50		
220	912.00			246	925.00		
221	912.50			247	925.50		
222	913.00			248	926.00		
223	913.50			249	926.50		
224	914.00			250	927.00		
225	914.50			251	927.50		
				252	928.00		

Table 16: Overview of the channels with remark relating to compliance, 50 Ω conducted.

## 11. Using the repeater functionality

The Telesto-I module can be run as a repeater to artificially extend the range of sending devices in an existing network.

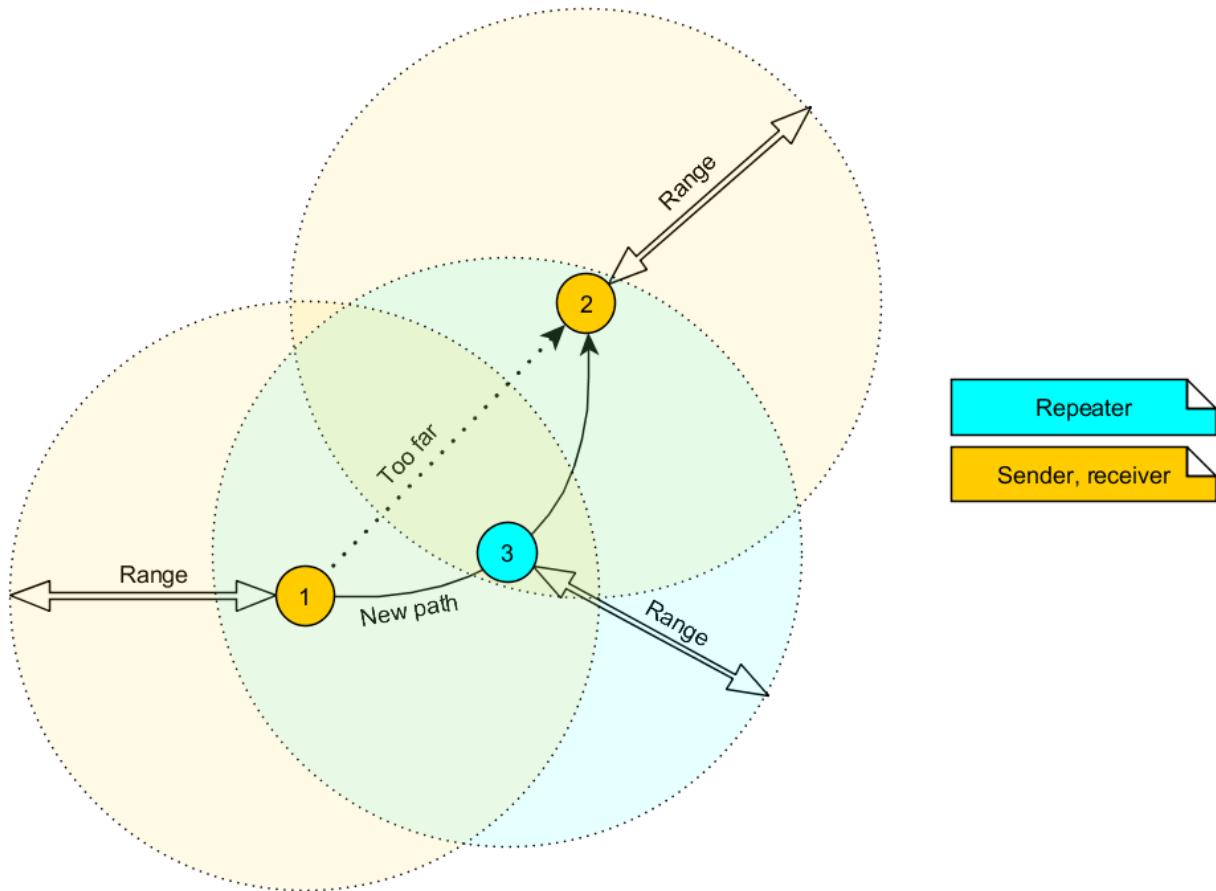

Figure 4: Range extension using repeaters

If the module is configured as repeater it can be simply added to existing wireless networks consisting of compatible modules. With this, the network uses the so called "flooding technique" to deliver data packets from their source to their destination device. With this feature the network builds a so called "flooding mesh".

The repeater module itself simply listens to the configured channel and forwards all received packets, whose destination address does not coincide with the repeater's source address or which are sent broadcast. A random delay (see parameter `RP_NumSlots`) is used to avoid RF packet collision. To reduce traffic on the frequency channel, each repeater device checks before repetition, if the channel is free and whether it has already sent this packet before or not. Thus every repeater sends each packet only once.

In a network with  $NumRP$  repeater devices, each data packet is repeated  $NumRP$  times. Therefore each packet that is sent from node A to node B forces a traffic of  $NumRP + 1$  data packets in total on the frequency channel.



A module that is configured as repeater simultaneously supports also the functions of a standard module. Thus, it can receive data and can initiate the data transmission to other modules.

## 11.1. Setup of the network and repeater device

The repeater mode can be enabled with setting bit 1 in the `RpFlags`.



As ACKs are not supported by the Repeater-Mode all network members must make sure that the `UserSettings` value of `MAC_NumRetrys` is set to 0. The repeater mode will automatically select `OpMode` 16 (Command mode). The transparent mode is not supported when repeater mode is selected. The user must adhere to the statutory regularity especially the duty cycle regarding EN 300 200 when applicable.

If the module device is configured as repeater, the following notes have to be considered:

Requirements on the network:

- The repeater devices have to be line-powered (no battery), since due to packet repetition it demands more energy.
- Depending on the data rate, each repeater should repeat a maximum of 2-5 packets per second to give a good chance that the repeater is not busy with repeating when already a new packet arrives for repetition. Otherwise, packets can get lost. Please setup your network such that this requirement is fulfilled. More packets per second will result in more packet loss as the collision probability is increased.
- If the network consists of several layers of repeaters, each layer delays the packet transmission additionally.
- To setup the network all participants have to use the same `RF_ConfigIndex`, `PHY_DefaultChannel` and `MAC_AddrMode`.

Information for the repeater device:

- Clear Channel Assessment (CCA) is forced to be enabled, the `UserSetting RF_CCADisabled` is ignored. The user must adopt all relevant CCA values to the system design and environment.
- The repeater module operates in command mode.
- Acknowledgments (ACK) of successfully received packets are blocked. If an ACK is requested by the sending module, the request is ignored. Furthermore, the repeater does not request any ACK, when repeating a packet.

- The "packet sniffer" mode cannot run at the same time as the module is in repeater mode. Thus the bit 7 in the `CfgFlags` is ignored.
- Each time a packet has been repeated a `CMD_REPEAT_IND` is printed over UART. Depending on the address mode the address of the involved devices is placed in the `CMD_REPEAT_IND` telegram. With this the original sender of the RF packet and the device, that is supposed to receive the packet, can be identified.

Information for the sending and receiving devices:

- The senders should send less frequently to avoid packet collision on the frequency channel and to not exceed the duty cycle.
- The repeater devices do not support the module feature of ACKs for the successful reception of the packets. Thus the sender will never receive ACKs if requested. To ensure that transmitted packets are successfully received by the destination device, the network administrator has to integrate his own acknowledging feature in the customer's application. To be sure that the sender does not request ACKs the user setting `MAC_NumRetrys` must be set to 0.
- Every repeater sends each packet only once. But receivers can receive each packet several times (sent by different repeaters), if there are packets of different content in the network temporally close to each other. Thus, on the side of the receiving device, a mechanism can be implemented that filters double packets.

## 11.2. Example network

In the example network shown above, the goal is to send a packet from device 1 to 5. Without the repeater devices, this would be impossible. The steps are as follows:

A Sender 1 sends a packet.

- a) Repeater 2 and 3 receive and accept it at the same time.

B Device 2 and 3 delay the packet

- a) Repeater 3 sends the packet.

- i Sender 1 and 6 do not accept it, since their addresses are wrong (unequal 5).
- ii Repeater 2 does not accept it, since it has been already received before (1.2).

- b) Repeater 2 sends the packet.

- i Repeaters 3 does not accept it, since it has been already received before (1.3).
- ii Sender 1 does not accept it, since its address is wrong (unequal 5).

- iii Repeater 4 receives and accepts the packet.

C Repeater 4 delays and sends the packet.

- a) Sender 6 and 7 do not accept it, since their addresses are wrong (unequal 5).
- b) Repeater 2 does not accept it, since it has been already received before (1.2).
- c) Receiver 5 accepts it and its successfully delivered (address equals 5)

Please note that the packet forwarded by repeater 2 and 3 would collide in the frequency channel, if they wouldn't be randomly delayed (see `RP_NumSlots`).



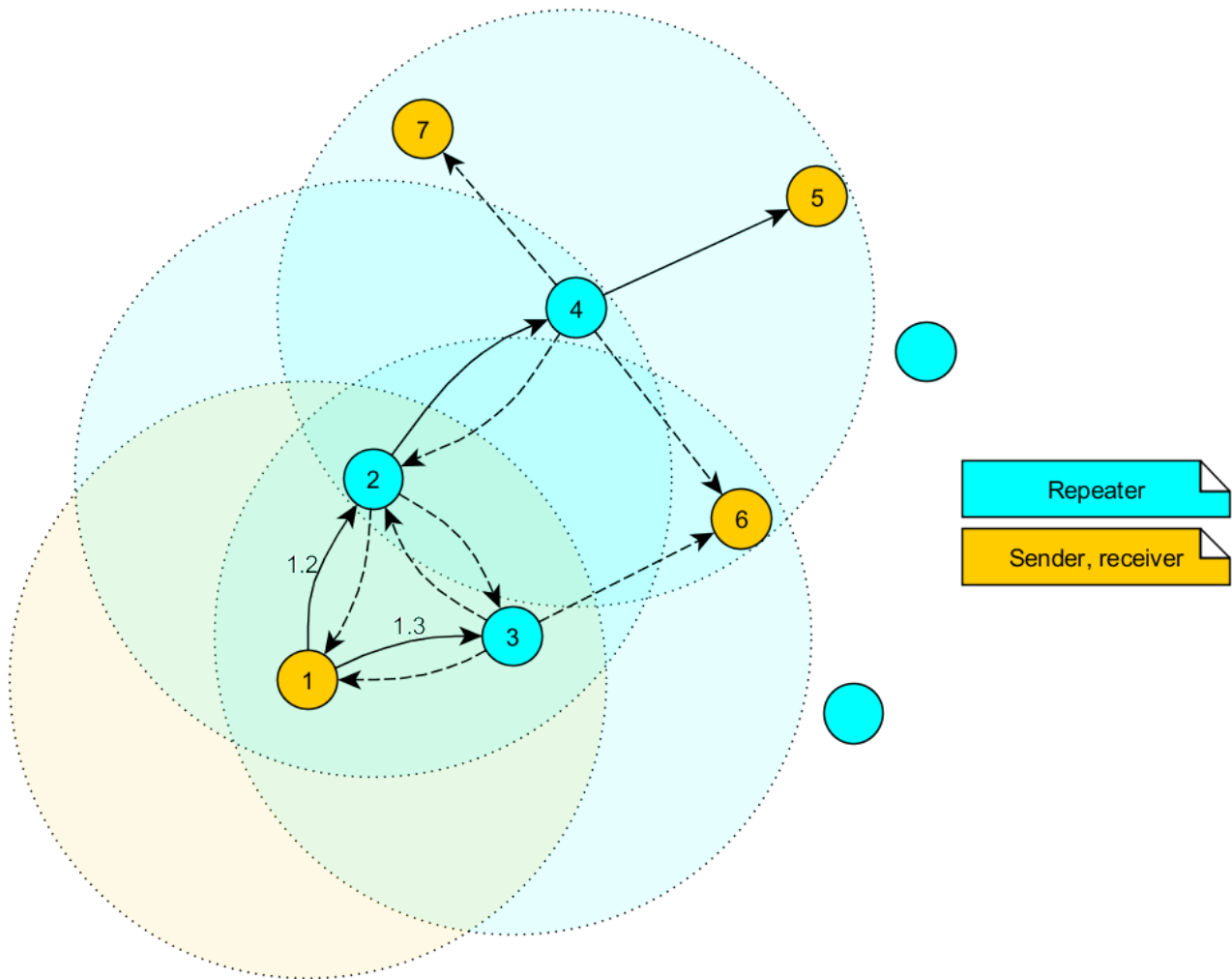

Figure 5: Example network

### 11.3. Application in parallel networks

As described above, a repeater device forwards all packets that are received before. If a network needs to have a bigger throughput of data, a parallel network can be set up, that relaxes the stress of the primal network. To do so, all sending, receiving and repeater devices of the parallel network are configured to use a new channel, such that the primal network is not affected at all by the traffic of the parallel network.

## 12. Battery powered operation

The *TRX\_DISABLE* pin can set the module to one of two different modes of operation.

### 12.1. Active mode

When *TRX\_DISABLE* is low, the module is permanently ready to receive and forward data via UART or wireless transmission. The module will switch to one of the internal LPM after having processed any pending data transmission, i.e. */RTS* must be low.

### 12.2. Stand-by mode

When *TRX\_DISABLE* is high, the operation of the module's transceiver is disabled. Wireless reception is not possible, but transmission of data is possible. The module will switch to one of the internal LPM as long as no data will be transmitted. A UART data rate of more than 9600 Baud will result in a higher current consumption.



The *CfgFlags* Bit 4 can modify this behavior (see chapter 8.22).

## **13. Custom firmware**

### **13.1. Custom configuration of standard firmware**

The configuration of the standard firmware includes adoption of the non-volatile Usersettings (see chapter 8) to customer requirements and creating a customized product based on the standard product.

This variant will result in a customer exclusive module with a unique ordering number. It will also freeze the firmware version to a specific and customer tested version and thus results in a customer exclusive module with a unique ordering number.

Further scheduled firmware updates of the standard firmware will not be applied to this variant automatically. Applying updates or further functions require a customer request and release procedure.

### **13.2. Customer specific firmware**

A customer specific firmware may include "Custom configuration of standard firmware" plus additional options or functions and tasks that are customer specific and not part of the standard firmware.

Further scheduled firmware updates of the standard firmware will not be applied to this variant automatically. Applying updates or further functions require a customer request and release procedure.

This also results in a customer exclusive module with a unique ordering number.

An example for this level of customization are functions like host-less operation where the module will perform data generation (e.g. by reading a SPI or I<sup>2</sup>C sensor) and cyclic transmission of this data to a data collector, while sleeping or being passive most of the time.

Also replacing UART with SPI as host communication interface is classified such a custom specific option.

Certification critical changes need to be re-evaluated by an external qualified measurement laboratory. These critical changes may occur when e.g. changing radio parameters, the channel access method, the duty-cycle or in case of various other functions and options possibly used or changed by a customer specific firmware.

### **13.3. Customer firmware**

A customer firmware is a firmware written and tested by the customer himself or a 3rd party as a customer representative specifically for the hardware platform provided by a module.

This customer firmware (e.g. in form of a Intel hex file) will be implemented into the module's production process at our production site.

This also results in a customer exclusive module with a unique ordering number.

The additional information needed for this type of customer firmware, such as hardware specific details and details towards the development of such firmware are not available for the public and can only be made available to qualified customers.



The qualification(s) and certification(s) of the standard firmware cannot be applied to this customer firmware solution without a review and verification.

### **13.4. Contact for firmware requests**

Please contact your local field sales engineer (FSE) or [WCS@we-online.com](mailto:WCS@we-online.com) for quotes regarding these topics.

## 14. Firmware updates

All products will experience maintenance, security and/or feature updates from time to time. For the standard products these maintained via the PCN process.

Customers can request the creation of a customized product including a "firmware freeze" to ensure that they will receive their verified product even if the standard product is updated.

### 14.1. Firmware flashing using the production interface

Most Würth Elektronik eiSos wireless connectivity modules offer a production interface (e.g. JTAG, SWD, Spy-Bi-Wire) for module flash access. Depending on the product, this interface can be used by customers to erase the entire chip and install their own firmware.

Using the production interface is not intended to perform updates of Würth Elektronik eiSos standard product firmware.

Production firmware images and binary files for Würth Elektronik eiSos wireless connectivity modules are not publicly available.



Any certification, declaration, listing and qualification becomes invalid if the production interface is used by a customer. Some products, in their documentation, state exceptions to this invalidation under certain conditions.

Customers shall make the product specific firmware update interface available to their application. These methods will use a wired (UART, SPI, etc.) or wireless (Bluetooth® LE, Wi-Fi, etc.) communication interface of the module to allow updating the product's firmware. Details are described in the next sections.

### 14.2. Update via ACC Software and UART

Only the *UTDX*, *URXD* and *GND* signals are needed for this connection. A suitable adapter/converter is required for a PC connection (e.g. the FTDI TTL-323R-3V3 UART to USB converter).



None of the module pins are 5 V TTL compatible. Applying overvoltage to any pin may damage the hardware permanently. Ensure your levels are in the range of the electrical specification as shown in chapter 2



Users must make sure that their host is not accessing the Telesto-I RX line (i.e. pulling it HIGH or LOW) as that will prevent ACC to access the module.

As long as our standard firmware is running on the module, it can be updated with the PC utility "ACC" via the serial interface. If the module is not directly connected to a PC, then at least the UART should be made accessible, e.g. by means of a suitable connector. ACC can be downloaded from the Würth Elektronik eiSos homepage: *ACC*.

## 15. Firmware history

### Version 3.4.7 "Production"

- First release for 915MHz band for FCC -2dBm compatibility

### Version 3.5.0 "Production"

- Code Maintenance
- Adopted to new version numbering requirement
- Unused module internal only pin termination changed.
- SPI line handling towards radio IC adopted to new method.

## 16. Design in guide

### 16.1. Advice for schematic and layout

For users with less RF experience it is advisable to closely copy the relating evaluation board with respect to schematic and layout, as it is a proven design. The layout should be conducted with particular care, because even small deficiencies could affect the radio performance and its range or even the conformity.

The following general advice should be taken into consideration:

- A clean, stable power supply is strongly recommended. Interference, especially oscillation can severely restrain range and conformity.
- Variations in voltage level should be avoided.
- LDOs, properly designed in, usually deliver a proper regulated voltage.
- Blocking capacitors and a ferrite bead in the power supply line can be included to filter and smoothen the supply voltage when necessary.



No fixed values can be recommended, as these depend on the circumstances of the application (main power source, interferences etc.).



The use of an external reset IC should be considered if one of the following points is relevant:



- The slew rate of the power supply exceeds the electrical specifications.
- The effect of different current consumptions on the voltage level of batteries or voltage regulators should be considered. The module draws higher currents in certain scenarios like start-up or radio transmit which may lead to a voltage drop on the supply. A restart under such circumstances should be prevented by ensuring that the supply voltage does not drop below the minimum specifications.
- Voltage levels below the minimum recommended voltage level may lead to malfunction. The /Reset pin of the module shall be held on LOW logic level whenever the VCC is not stable or below the minimum operating Voltage.
- Special care must be taken in case of battery powered systems.



- Elements for ESD protection should be placed on all pins that are accessible from the outside and should be placed close to the accessible area. For example, the RF-pin is accessible when using an external antenna and should be protected.
- ESD protection for the antenna connection must be chosen such as to have a minimum effect on the RF signal. For example, a protection diode with low capacitance such as the 8231606A or a 68 nH air-core coil connecting the RF-line to ground give good results.
- Placeholders for optional antenna matching or additional filtering are recommended.
- The antenna path should be kept as short as possible.



Again, no fixed values can be recommended, as they depend on the influencing circumstances of the application (antenna, interferences etc.).

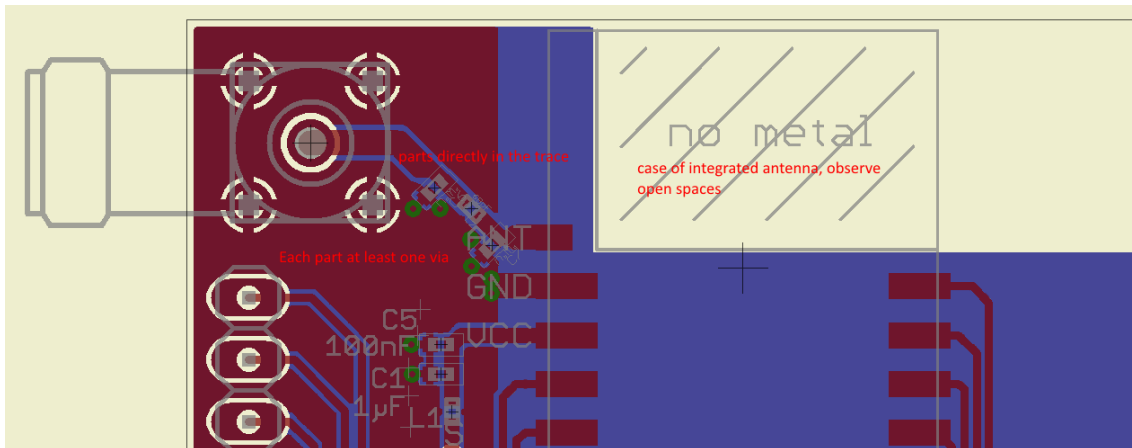

Figure 6: Layout

- To avoid the risk of short circuits and interference there should be no routing underneath the module on the top layer of the baseboard.
- On the second layer, a ground plane is recommended, to provide good grounding and shielding to any following layers and application environment.
- In case of integrated antennas it is required to have areas free from ground. This area should be copied from the evaluation board.
- The area with the integrated antenna must overlap with the carrier board and should not protrude, as it is matched to sitting directly on top of a PCB.
- Modules with integrated antennas should be placed with the antenna at the edge of the main board. It should not be placed in the middle of the main board or far away from the edge. This is to avoid tracks beside the antenna.

- Filter and blocking capacitors should be placed directly in the tracks without stubs, to achieve the best effect.
- Antenna matching elements should be placed close to the antenna / connector, blocking capacitors close to the module.
- Ground connections for the module and the capacitors should be kept as short as possible and with at least one separate through hole connection to the ground layer.
- ESD protection elements should be placed as close as possible to the exposed areas.

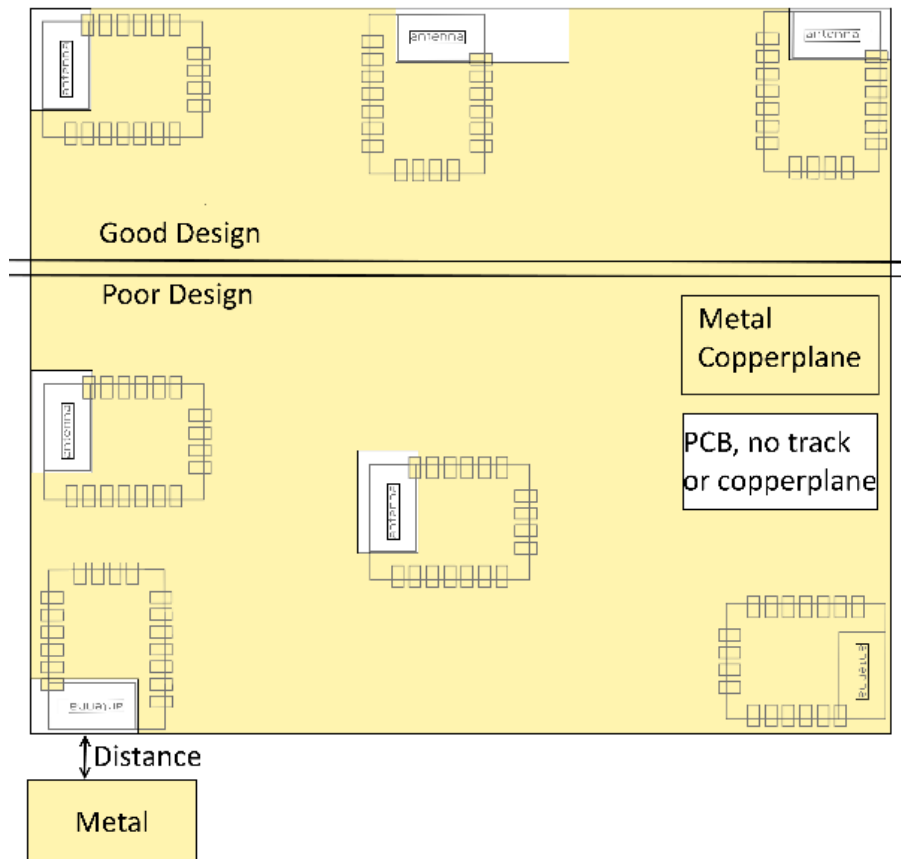

Figure 7: Placement of the module with integrated antenna

## 16.2. Dimensioning of the micro strip antenna line

The antenna track has to be designed as a 50 Ω feed line. The width W for a micro strip can be calculated using the following equation:

$$W = 1.25 \times \left( \frac{5.98 \times H}{e^{\frac{50 \times \sqrt{\epsilon_r + 1.41}}{87}}} - T_{met} \right) \quad (2)$$

Example:

A FR4 material with  $\epsilon_r = 4.3$ , a height  $H = 1000 \mu\text{m}$  and a copper thickness of  $T_{met} = 18 \mu\text{m}$  will

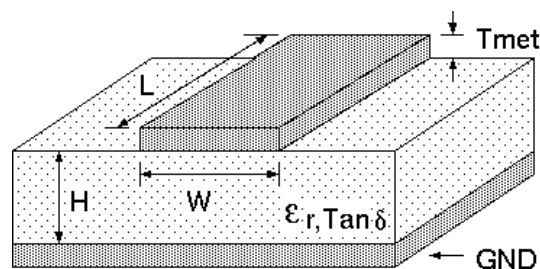

Figure 8: Dimensioning the antenna feed line as micro strip

lead to a trace width of  $W \sim 1.9$  mm. To ease the calculation of the micro strip line (or e.g. a coplanar) many calculators can be found in the internet.

- As rule of thumb a distance of about  $3 \times W$  should be observed between the micro strip and other traces / ground.
- The micro strip refers to ground, therefore there has to be the ground plane underneath the trace.
- Keep the feeding line as short as possible.

### 16.3. Antenna solutions

There exist several kinds of antennas, which are optimized for different needs. Chip antennas are optimized for minimal size requirements but at the expense of range, PCB antennas are optimized for minimal costs, and are generally a compromise between size and range. Both usually fit inside a housing.

Range optimization in general is at the expense of space. Antennas that are bigger in size, so that they would probably not fit in a small housing, are usually equipped with a RF connector. A benefit of this connector may be to use it to lead the RF signal through a metal plate (e.g. metal housing, cabinet).

As a rule of thumb a minimum distance of  $\lambda / 10$  (which is 3.5 cm @ 868 MHz and 1.2 cm @ 2.44 GHz) from the antenna to any other metal should be kept. Metal placed further away will not directly influence the behavior of the antenna, but will anyway produce shadowing.



Keep the antenna as far as possible from large metal objects to avoid electromagnetic field blocking.



The choice of antenna might have influence on the safety requirements.

In the following chapters, some special types of antenna are described.

### **16.3.1. Wire antenna**

An effective antenna is a  $\lambda / 4$  radiator with a suiting ground plane. The simplest realization is a piece of wire. It's length is depending on the used radio frequency, so for example 8.6 cm 868.0 MHz and 3.1 cm for 2.440 GHz as frequency. This radiator needs a ground plane at its feeding point. Ideally, it is placed vertically in the middle of the ground plane. As this is often not possible because of space requirements, a suitable compromise is to bend the wire away from the PCB respective to the ground plane. The  $\lambda / 4$  radiator has approximately 40  $\Omega$  input impedance. Therefore, matching is not required.

### **16.3.2. Chip antenna**

There are many chip antennas from various manufacturers. The benefit of a chip antenna is obviously the minimal space required and reasonable costs. However, this is often at the expense of range. For the chip antennas, reference designs should be followed as closely as possible, because only in this constellation can the stated performance be achieved.

### **16.3.3. PCB antenna**

PCB antenna designs can be very different. The special attention can be on the miniaturization or on the performance. The benefits of the PCB antenna are their small / not existing (if PCB space is available) costs, however the evaluation of a PCB antenna holds more risk of failure than the use of a finished antenna. Most PCB antenna designs are a compromise of range and space between chip antennas and connector antennas.

**16.3.4. Antennas provided by Würth Elektronik eiSos**

**16.3.4.1. 2600130081 - Hyperion-I - 868 MHz dipole antenna**



Figure 9: 868 MHz dipole-antenna

Ideally suited for applications where no ground plane is available.



The 2600130081 antenna can be also used for 902MHz - 928MHz range.

Specification	Value
Center frequency [MHz]	868
Frequency range [MHz]	853 – 883
Wavelength	0.5 wave
VSWR	≤ 2.0
Impedance [Ω]	50
Connector	SMA (Male)
Dimensions (L x d) [mm]	142 x 10
Peak gain [dBi]	-2.3
Operating temp. [°C]	-30 – +80

## 16.3.4.2. 2600130083 - Hydra-I - 915 MHz dipole antenna



Figure 10: 915 MHz dipole-antenna

Ideally suited for applications where no ground plane is available.

Specification	Value
Center frequency [MHz]	915
Frequency range [MHz]	868 – 928
VSWR	$\leq 2.5$
Wavelength	0.25 wave
Impedance [ $\Omega$ ]	50
Connector	SMA (Male)
Dimensions (L x d) [mm]	179 x 10
Peak gain [dBi]	0.9
Operating temp. [ $^{\circ}\text{C}$ ]	-40 – +80

## 17. Reference design

Telesto-I was tested and certified on the corresponding Telesto-I evaluation board. For the compliance with the EU directive 2014/53/EU Annex I, the evaluation board serves as reference design.

This is no discrepancy due to the fact that the evaluation board itself does not fall within the scope of the EU directive 2014/53/EU Annex I as the module is tested on the evaluation board, which is also the recommended use.

Further information concerning the use of the evaluation board can be found in the manual of the Telesto-I evaluation board.

17.1. Schematic

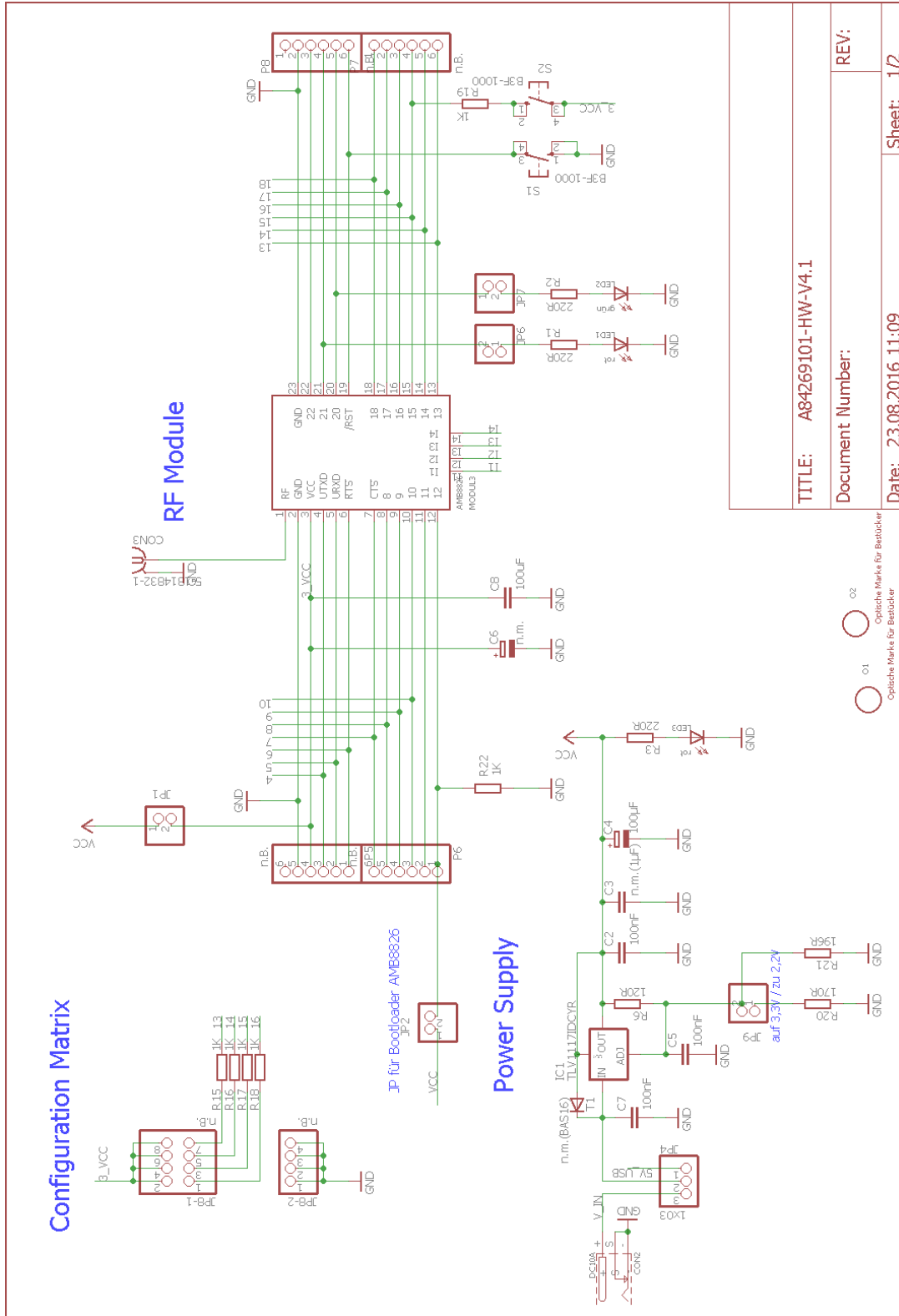

TITLE: A84269101-HW-V4.1	REV:
Document Number:	Sheet: 1/2
Date: 23.08.2016 11:09	





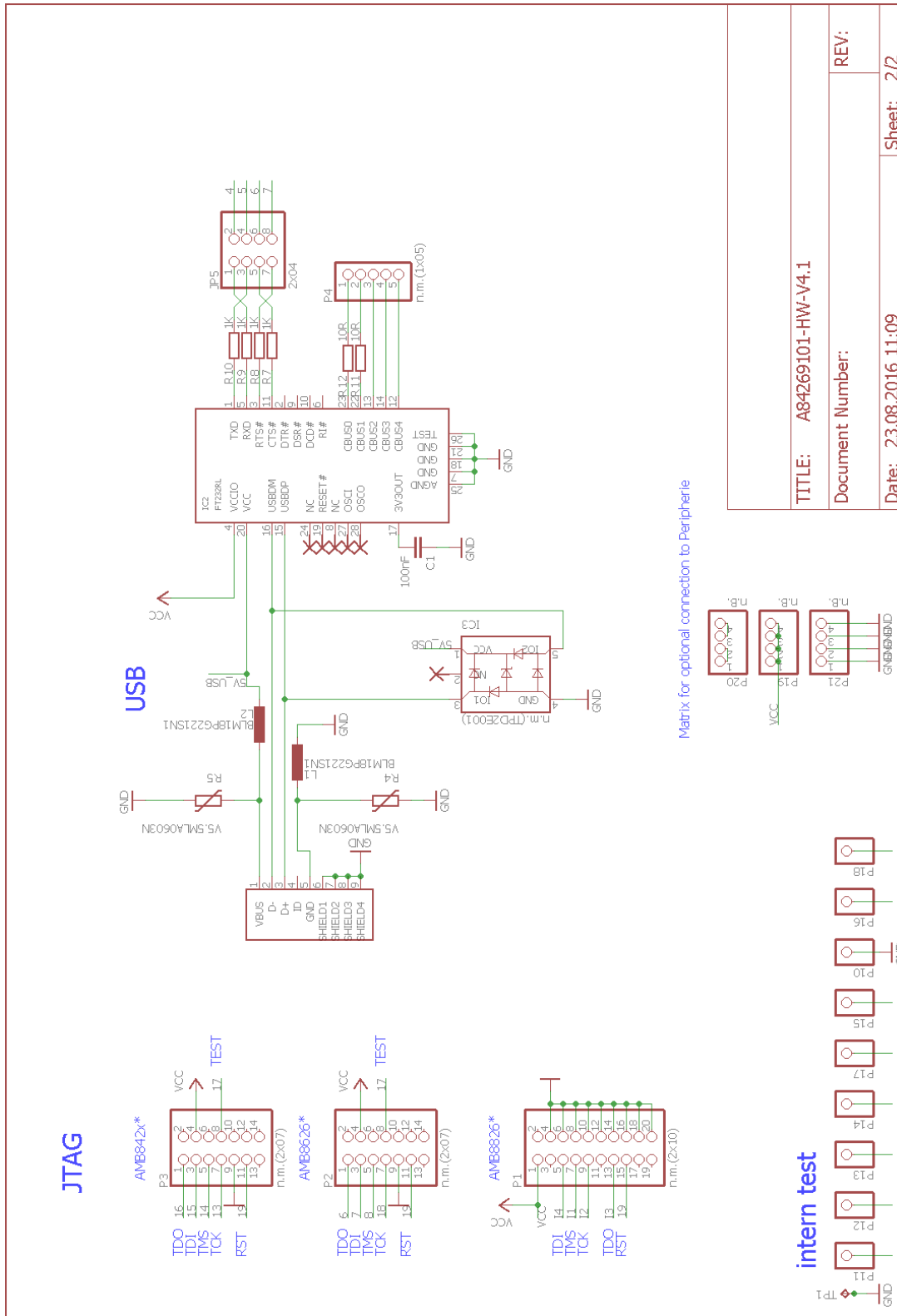

## 17.2. Layout

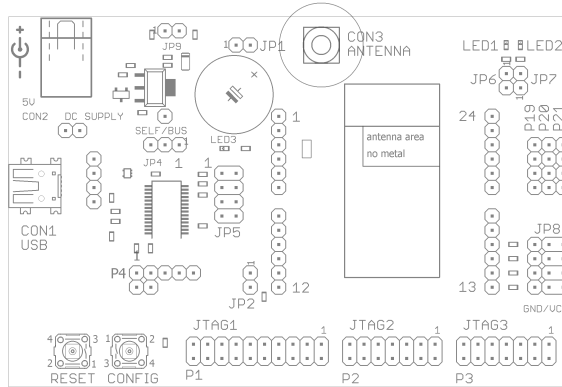

Figure 11: Assembly diagram

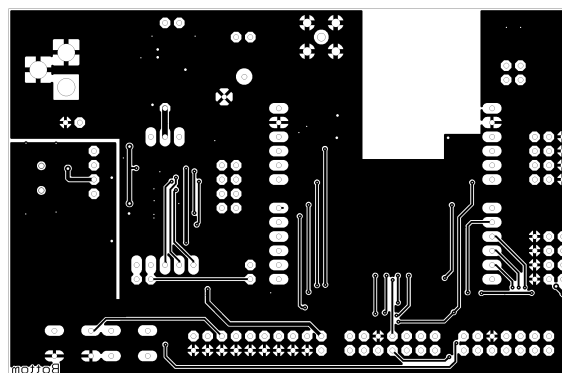
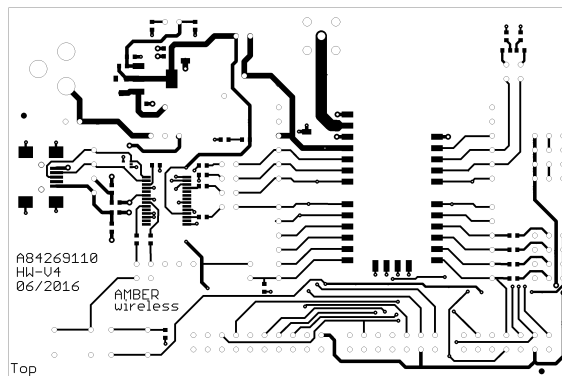

Figure 12: Top and Bottom Layer

## 18. Manufacturing information

### 18.1. Moisture sensitivity level

This wireless connectivity product is categorized as JEDEC Moisture Sensitivity Level 3 (MSL3), which requires special handling.

More information regarding the MSL requirements can be found in the IPC/JEDEC J-STD-020 standard on [www.jedec.org](http://www.jedec.org).

More information about the handling, picking, shipping and the usage of moisture/reflow and/or process sensitive products can be found in the IPC/JEDEC J-STD-033 standard on [www.jedec.org](http://www.jedec.org).

### 18.2. Soldering

#### 18.2.1. Reflow soldering

Attention must be paid on the thickness of the solder resist between the host PCB top side and the modules bottom side. Only lead-free assembly is recommended according to JEDEC J-STD020.

Profile feature		Value
Preheat temperature Min	$T_{S \text{ Min}}$	150 °C
Preheat temperature Max	$T_{S \text{ Max}}$	200 °C
Preheat time from $T_{S \text{ Min}}$ to $T_{S \text{ Max}}$	$t_S$	60 - 120 seconds
Ramp-up rate ( $T_L$ to $T_P$ )		3 °C / second max.
Liquidous temperature	$T_L$	217 °C
Time $t_L$ maintained above $T_L$	$t_L$	60 - 150 seconds
Peak package body temperature	$T_P$	see table below
Time within 5 °C of actual peak temperature	$t_P$	20 - 30 seconds
Ramp-down Rate ( $T_P$ to $T_L$ )		6 °C / second max.
Time 20 °C to $T_P$		8 minutes max.

Table 17: Classification reflow soldering profile, Note: refer to IPC/JEDEC J-STD-020E

Package thickness	Volume mm <sup>3</sup> <350	Volume mm <sup>3</sup> 350-2000	Volume mm <sup>3</sup> >2000
< 1.6 mm	260 °C	260 °C	260 °C
1.6 mm - 2.5 mm	260 °C	250 °C	245 °C
> 2.5 mm	250 °C	245 °C	245 °C

Table 18: Package classification reflow temperature, PB-free assembly, Note: refer to IPC/-JEDEC J-STD-020E

It is recommended to solder this module on the last reflow cycle of the PCB. For solder paste use a LFM-48W or Indium based SAC 305 alloy (Sn 96.5 / Ag 3.0 / Cu 0.5 / Indium 8.9HF / Type 3 / 89%) type 3 or higher.

The reflow profile must be adjusted based on the thermal mass of the entire populated PCB, heat transfer efficiency of the reflow oven and the specific type of solder paste used. Based on the specific process and PCB layout the optimal soldering profile must be adjusted and verified. Other soldering methods (e.g. vapor phase) have not been verified and have to be validated by the customer at their own risk. Rework is not recommended.

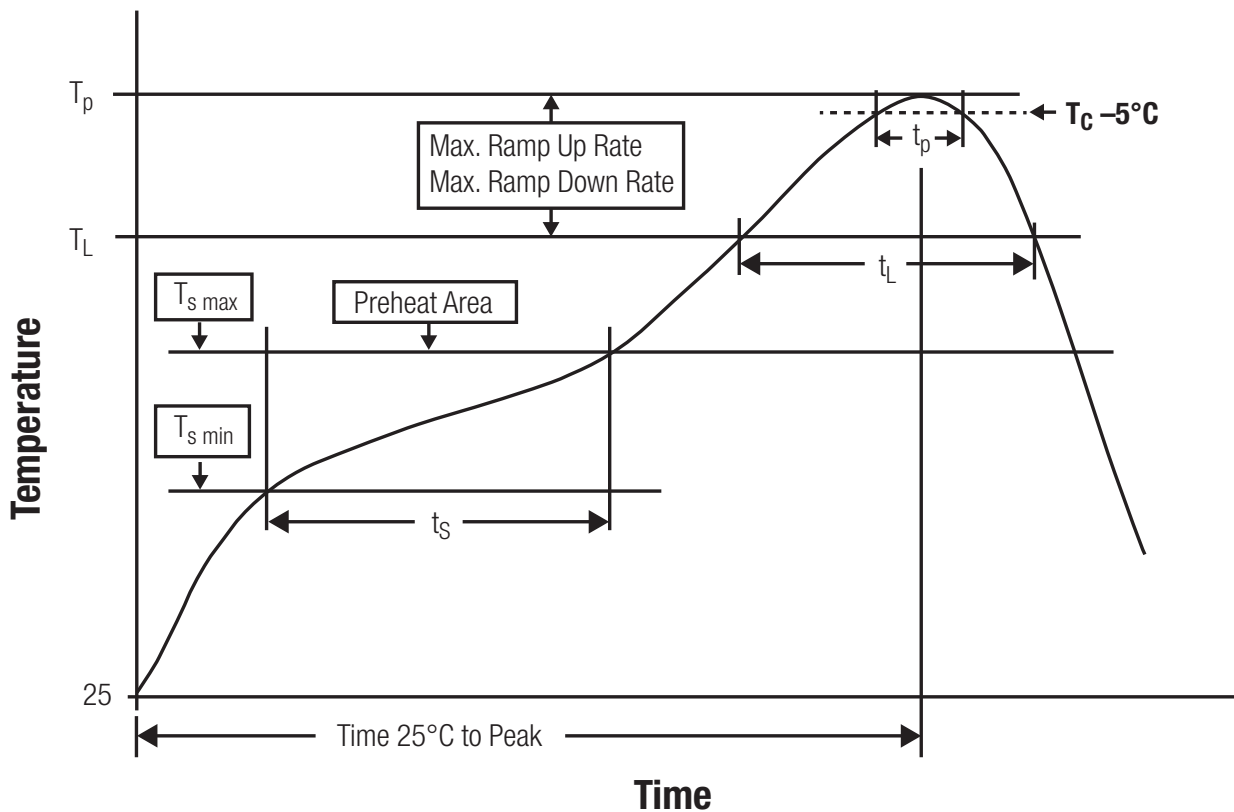

Figure 13: Reflow soldering profile

After reflow soldering, visually inspect the board to confirm proper alignment

### **18.2.2. Cleaning**

Do not clean the product. Any residue cannot be easily removed by washing. Use a "no clean" soldering paste and do not clean the board after soldering.

- Do not clean the product with water. Capillary effects can draw water into the gap between the host PCB and the module, absorbing water underneath it. If water is trapped inside, it may short-circuit adjoining pads. The water may also destroy the label and ink-jet printed text on it.
- Cleaning processes using alcohol or other organic solvents may draw solder flux residues into the housing, which won't be detected in a post-wash inspection. The solvent may also destroy the label and ink-jet printed text on it.
- Do not use ultrasonic cleaning as it will permanently damage the part, particularly the crystal oscillators.

### **18.2.3. Potting and coating**

- If the product is potted in the customer application, the potting material might shrink or expand during and after hardening. Shrinking could lead to an incomplete seal, allowing contaminants into the component. Expansion could damage components. We recommend a manual inspection after potting to avoid these effects.
- Conformal coating or potting results in loss of warranty.
- The RF shield will not protect the part from low-viscosity coatings and potting. An undefined amount of coating and potting will enter inside the shielding.
- Conformal coating and potting will influence the parts of the radio front end and consequently influence the radio performance.
- Potting will influence the temperature behaviour of the device. This might be critical for components with high power.

### **18.2.4. Other notations**

- Do not attempt to improve the grounding by forming metal strips directly to the EMI covers or soldering on ground cables, as it may damage the part and will void the warranty.
- Always solder every pad to the host PCB even if some are unused, to improve the mechanical strength of the module.
- The part is sensitive to ultrasonic waves, as such do not use ultrasonic cleaning, welding or other processing. Any ultrasonic processing will void the warranty.

### 18.3. ESD handling

This product is highly sensitive to electrostatic discharge (ESD). As such, always use proper ESD precautions when handling. Make sure to handle the part properly throughout all stages of production, including on the host PCB where the module is installed. For ESD ratings, refer to the module series' maximum ESD section. For more information, refer to the relevant chapter 2. Failing to follow the aforementioned recommendations can result in severe damage to the part.

- the first contact point when handling the PCB is always between the local GND and the host PCB GND, unless there is a galvanic coupling between the local GND (for example work table) and the host PCB GND.
- Before assembling an antenna patch, connect the grounds.
- While handling the RF pin, avoid contact with any charged capacitors and be careful when contacting any materials that can develop charges (for example coaxial cable with around 50-80 pF/m, patch antenna with around 10 pF, soldering iron etc.)
- Do not touch any exposed area of the antenna to avoid electrostatic discharge. Do not let the antenna area be touched in a non ESD-safe manner.
- When soldering, use an ESD-safe soldering iron.

### 18.4. Safety recommendations

It is your duty to ensure that the product is allowed to be used in the destination country and within the required environment. Usage of the product can be dangerous and must be tested and verified by the end user. Be especially careful of:

- Use in areas with risk of explosion (for example oil refineries, gas stations).
- Use in areas such as airports, aircraft, hospitals, etc., where the product may interfere with other electronic components.

It is the customer's responsibility to ensure compliance with all applicable legal, regulatory and safety-related requirements as well as applicable environmental regulations. Disassembling the product is not allowed. Evidence of tampering will void the warranty.

- Compliance with the instructions in the product manual is recommended for correct product set-up.
- The product must be provided with a consolidated voltage source. The wiring must meet all applicable fire and security prevention standards.
- Handle with care. Avoid touching the pins as there could be ESD damage.

Be careful when working with any external components. When in doubt consult the technical documentation and relevant standards. Always use an antenna with the proper characteristics.



Würth Elektronik eiSos radio modules with high output power of up to 500 mW, as for example the radio module Thebe-II, generate a high amount of warmth while transmitting. The manufacturer of the end device must take care of potentially necessary actions for his application.

## 19. Physical specifications

### 19.1. Dimensions

Dimensions
17 x 27 x 3.8 mm

Table 19: Dimensions

### 19.2. Weight

Weight
3g

Table 20: Weight



### 19.3. Module drawing

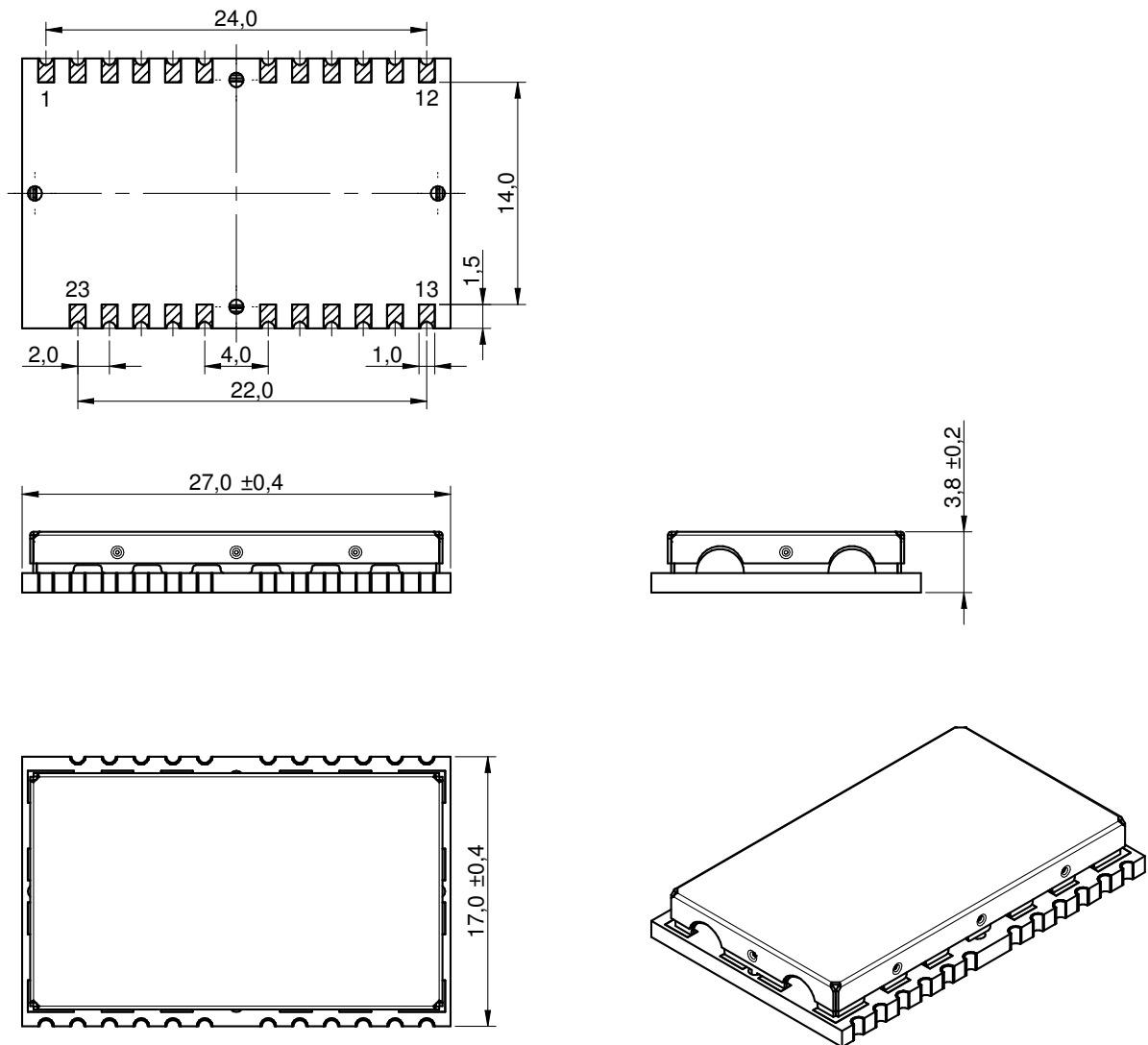

Figure 14: Module dimensions [mm]

## 19.4. Footprint

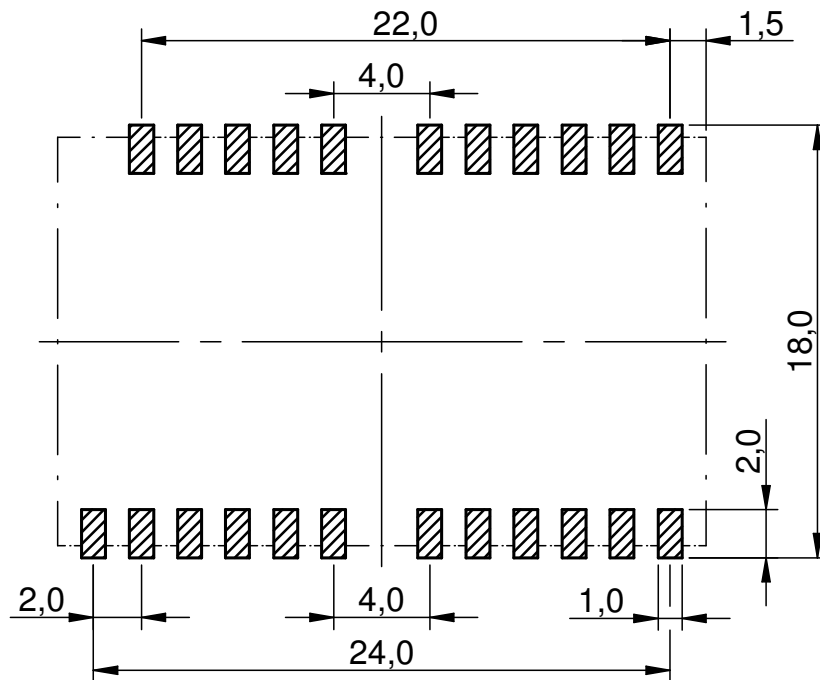

Figure 15: Footprint and dimensions [mm]

## 19.5. Antenna free area

To avoid influence and mismatching of the antenna the recommended free area around the antenna should be maintained. As rule of thumb a minimum distance of metal parts to the antenna of  $\lambda/10$  should be kept (see figure 15). Even though metal parts would influence the characteristic of the antenna, but the direct influence and matching keep an acceptable level.

## 20. Marking

### 20.1. Lot number

The 15 digit lot number is printed in numerical digits as well as in form of a machine readable bar code. It is divided into 5 blocks as shown in the following picture and can be translated according to the following table.

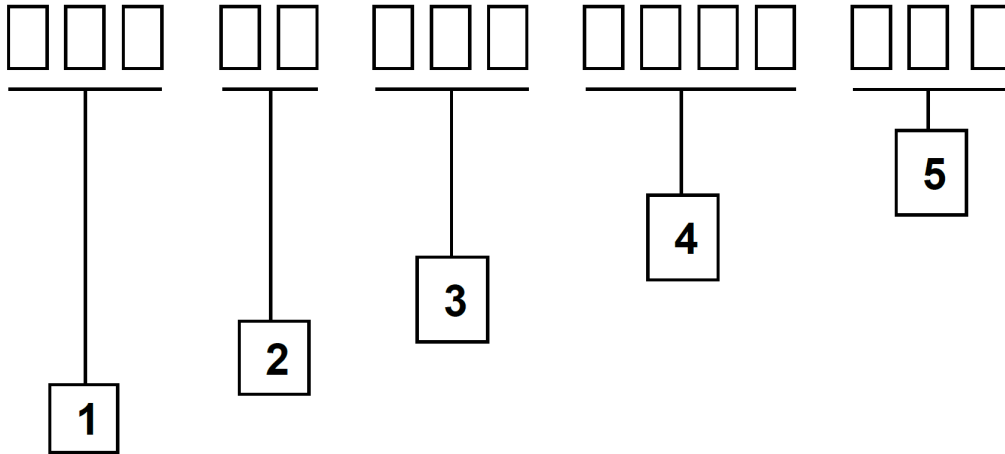

Figure 16: Lot number structure

Block	Information	Example(s)
1	eiSos internal, 3 digits	439
2	eiSos internal, 2 digits	01
3	Hardware version, 3 digits	V2.4 = 024, V12.2 = 122
4	Date code, 4 digits	1703 = week 03 in year 2017, 1816 = week 16 in year 2018
5	Firmware version, 3 digits	V3.2 = 302, V5.13 = 513

Table 21: Lot number details

As the user can perform a firmware update the printed lot number only shows the factory delivery state. The currently installed firmware can be requested from the module using the corresponding product specific command. The firmware version as well as the hardware version are restricted to show only major and minor version not the patch identifier.

## 20.2. General labeling information

The module labels may include the following fields:

- Manufacturer identification WE, Würth Elektronik or Würth Elektronik eiSos
- WE Order Code and/or article alias
- Serial number or MAC address
- Certification identifiers (CE, FCC ID, IC, TELEC,...)
- Bar code or 2D code containing the serial number or MAC address

If the module is using a serial Number, this serial number includes the product ID (PID) and an 6 digit number. The 6 rightmost digits represent the 6 digit number, followed by the product ID (2 or 3 digits). Some labels indicate the product ID with a "." as marker in-between the 2 fields. The PID and the 6 digit number form together a unique serial number for any wireless connectivity product.

In case of small labels, the 3 byte manufacturer identifier (0x0018DA) of the MAC address is not printed on the labels. The 3 byte counter printed on the label can be used with this 0018DA to produce the full MAC address by appending the counter after the manufacturer identifier.



Figure 17: Label of the Telesto-I

## 21. Information for explosion protection

In case the end product should be used in explosion protection areas the following information can be used:

- The maximum output power of the module is -2 dBm.
- The total amount of capacitance of all capacitors is 320.9 nF.
- The total amount of inductance of all inductors is 1.042  $\mu$ H.

## **22. Regulatory compliance information**

### **22.1. Important notice FCC**

The use of RF frequencies is limited by national regulations. The Telesto-I has been designed to comply with the FCC Part 15.

The Telesto-I can be operated without notification and free of charge in the area of the United States of America. However, according to the FCC Part 15, restrictions (e.g. in terms of maximum allowed RF power and antenna) may apply.

### **22.2. Conformity assessment of the final product**

The Telesto-I is a subassembly. It is designed to be embedded into other products (products incorporating the Telesto-I are henceforward referred to as "final products").

It is the responsibility of the manufacturer of the final product to ensure that the final product is in compliance with the essential requirements of the underlying national radio regulations.

The conformity assessment of the subassembly Telesto-I carried out by Würth Elektronik eiSos does not replace the required conformity assessment of the final product.

### **22.3. Exemption clause**

Relevant regulation requirements are subject to change. Würth Elektronik eiSos does not guarantee the accuracy of the before mentioned information. Directives, technical standards, procedural descriptions and the like may be interpreted differently by the national authorities. Equally, the national laws and restrictions may vary with the country. In case of doubt or uncertainty, we recommend that you consult with the authorities or official certification organizations of the relevant countries. Würth Elektronik eiSos is exempt from any responsibilities or liabilities related to regulatory compliance.

Notwithstanding the above, Würth Elektronik eiSos makes no representations and warranties of any kind related to their accuracy, correctness, completeness and/or usability for customer applications. No responsibility is assumed for inaccuracies or incompleteness.

## 22.4. FCC Compliance Statement (US)

FCC ID: R7TAMB9625

This device complies with Part 15 of the FCC Rules.

Operation is subject to the following two conditions:

- (1) this device may not cause harmful interference, and
  - (2) this device must accept any interference received, including interference that may cause undesired operation.
- (FCC 15.19)

Modifications (FCC 15.21)

Caution: Changes or modifications for this equipment not expressly approved by Würth Elektronik eiSos may void the FCC authorization to operate this equipment.

### 22.4.1. FCC certificate

FCC - OET TCB Form 731 Grant of Equipment Authorization Page 1 of 1

**TCB**

**GRANT OF EQUIPMENT AUTHORIZATION**

Certification  
Issued Under the Authority of the  
Federal Communications Commission

By:

Telefication B.V.  
Edisonstraat 12a  
Zevenaar, NL-6902 PK  
Netherlands

Date of Grant: 10/11/2017  
Application Dated: 10/11/2017

**TCB**

**AMBER Wireless GmbH**  
Rudi-Schillings-Str. 31  
Trier, 54296  
Germany

Attention: Oliver Opitz , Manager

**NOT TRANSFERABLE**

EQUIPMENT AUTHORIZATION is hereby issued to the named GRANTEE, and is VALID ONLY for the equipment identified hereon for use under the Commission's Rules and Regulations listed below.

FCC IDENTIFIER: R7TAMB9625  
Name of Grantee: AMBER Wireless GmbH  
Equipment Class: Part 15 Low Power Transceiver, Rx  
Verified  
Notes: AMB9625  
Modular Type: Single Modular

Grant Notes	FCC Rule Parts	Frequency Range (MHz)	Output Watts	Frequency Tolerance	Emission Designator
	15C	902.5 - 927.5			

Modular approval.

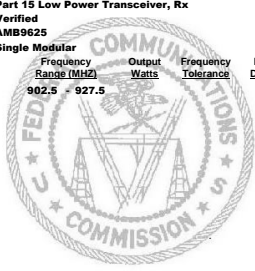

<https://apps.fcc.gov/oetcf/tcb/reports/Tcb731GrantForm.cfm> 11-10-2017

Figure 18: FCC certificate

## 22.5. IC Compliance Statement (Canada)

Certification Number: 5136A-AMB9625

HVIN: AMB9625

This device complies with Industry Canada licence-exempt RSS standard(s). Operation is subject to the following two conditions: (1) this device may not cause harmful interference, and (2) this device must accept any interference received, including interference that may cause undesired operation.

Le présent appareil est conforme aux CNR d'Industrie Canada applicables aux appareils radio exempts de licence. L'exploitation est autorisée aux deux conditions suivantes : (1) l'appareil ne doit pas produire de brouillage, et (2) l'utilisateur de l'appareil doit accepter tout brouillage radioélectrique subi, même si le brouillage est susceptible d'en compromettre le fonctionnement.

### 22.5.1. IC certificate

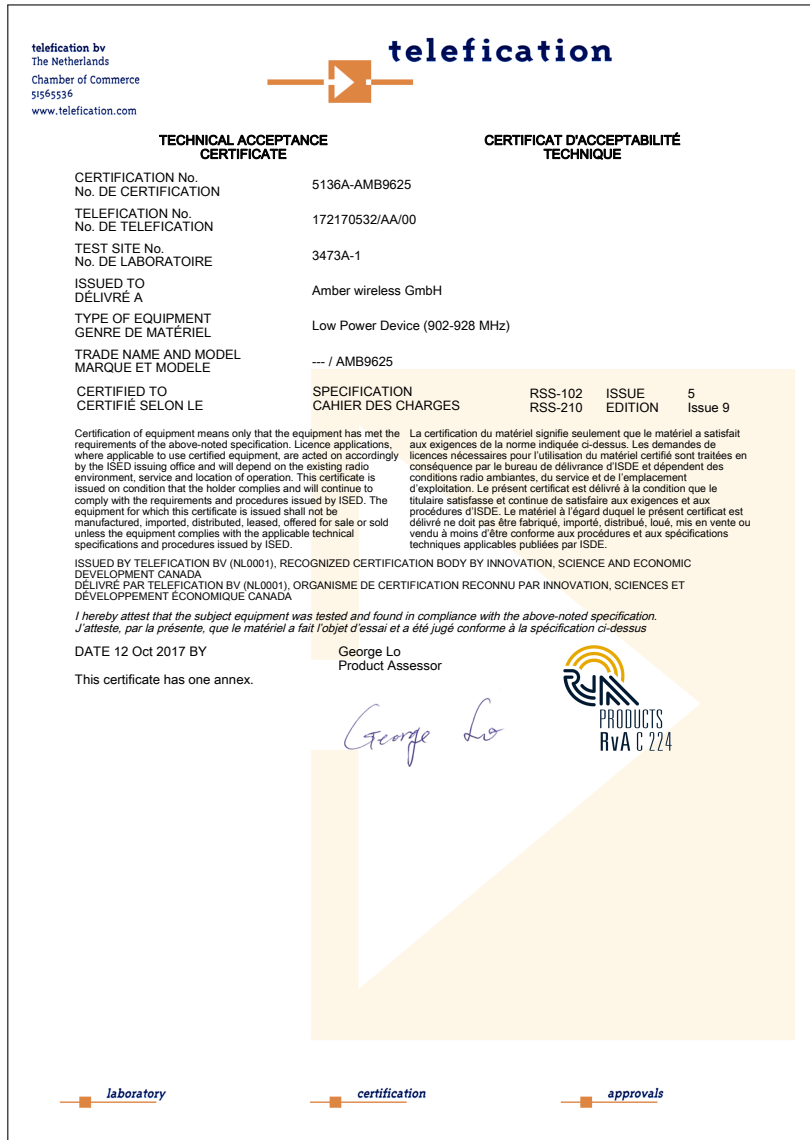

Figure 19: IC certificate



## 22.6. FCC and IC requirements to OEM integrators

This module has been granted modular approval. OEM integrators for host products may use the module in their final products without additional FCC/IC (Industry Canada) certification if they meet the following conditions. Otherwise, additional FCC/IC approvals must be obtained. The host product with the module installed must be evaluated for simultaneous transmission requirements.

- The users manual for the host product must clearly indicate the operating requirements and conditions that must be observed to ensure compliance with current FCC/IC RF exposure guidelines.
- To comply with FCC/IC regulations limiting both maximum RF output power and human exposure to RF radiation, the maximum antenna gain including cable loss in a mobile-only exposure condition must not exceed 2 dBi.
- A label must be affixed to the outside of the host product with the following statements:  
This device contains FCCID: R7TAMB9625  
This equipment contains equipment certified under ICID: 5136A-AMB9625
- The final host / module combination may also need to be evaluated against the FCC Part 15B criteria for unintentional radiators in order to be properly authorized for operation as a Part 15 digital device.
- If the final host / module combination is intended for use as a portable device (see classifications below) the host manufacturer is responsible for separate approvals for the SAR requirements from FCC Part 2.1093 and RSS-102.

### **OEM requirements:**

The OEM must ensure that the following conditions are met.

- End users of products, which contain the module, must not have the ability to alter the firmware that governs the operation of the module. The agency grant is valid only when the module is incorporated into a final product by OEM integrators.
- The end-user must not be provided with instructions to remove, adjust or install the module.
- The Original Equipment Manufacturer (OEM) must ensure that FCC labeling requirements are met. This includes a clearly visible label on the outside of the final product. Attaching a label to a removable portion of the final product, such as a battery cover, is not permitted.
- The label must include the following text:  
*Contains FCC ID: R7TAMB9625*  
*The enclosed device complies with Part 15 of the FCC Rules. Operation is subject to the following two conditions:*  
*(i.) this device may not cause harmful interference and*  
*(ii.) this device must accept any interference received, including interference that may cause undesired operation.*

When the device is so small or for such use that it is not practicable to place the statement above on it, the information required by this paragraph shall be placed in a prominent location in the instruction manual or pamphlet supplied to the user or, alternatively, shall be placed on the container in which the device is marketed. However, the FCC identifier or the unique identifier, as appropriate, must be displayed on the device.

- The user manual for the end product must also contain the text given above.
  - Changes or modifications not expressly approved could void the user’s authority to operate the equipment.
  - The OEM must ensure that timing requirements according to 47 CFR 15.231(a-c) are met.
  - The OEM must sign the OEM Modular Approval Agreement.
  - The module must be used with only the following approved antenna(s).

## 22.7. Pre-certified antennas

The Telesto-I is pre-certified with the following antennas.

Product	Certified antenna
AMB9625	$\lambda/4$ wire antenna as specified in chapter 16.3.1

## **23. Important notes**

The following conditions apply to all goods within the wireless connectivity product range of Würth Elektronik eiSos GmbH & Co. KG:

### **23.1. General customer responsibility**

Some goods within the product range of Würth Elektronik eiSos GmbH & Co. KG contain statements regarding general suitability for certain application areas. These statements about suitability are based on our knowledge and experience of typical requirements concerning the areas, serve as general guidance and cannot be estimated as binding statements about the suitability for a customer application. The responsibility for the applicability and use in a particular customer design is always solely within the authority of the customer. Due to this fact, it is up to the customer to evaluate, where appropriate to investigate and to decide whether the device with the specific product characteristics described in the product specification is valid and suitable for the respective customer application or not. Accordingly, the customer is cautioned to verify that the documentation is current before placing orders.

### **23.2. Customer responsibility related to specific, in particular safety-relevant applications**

It has to be clearly pointed out that the possibility of a malfunction of electronic components or failure before the end of the usual lifetime cannot be completely eliminated in the current state of the art, even if the products are operated within the range of the specifications. The same statement is valid for all software sourcecode and firmware parts contained in or used with or for products in the wireless connectivity and sensor product range of Würth Elektronik eiSos GmbH & Co. KG. In certain customer applications requiring a high level of safety and especially in customer applications in which the malfunction or failure of an electronic component could endanger human life or health, it must be ensured by most advanced technological aid of suitable design of the customer application that no injury or damage is caused to third parties in the event of malfunction or failure of an electronic component.

### **23.3. Best care and attention**

Any product-specific data sheets, manuals, application notes, PCN's, warnings and cautions must be strictly observed in the most recent versions and matching to the products firmware revisions. This documents can be downloaded from the product specific sections on the wireless connectivity homepage.

### **23.4. Customer support for product specifications**

Some products within the product range may contain substances, which are subject to restrictions in certain jurisdictions in order to serve specific technical requirements. Necessary information is available on request. In this case, the field sales engineer or the internal sales person in charge should be contacted who will be happy to support in this matter.

## **23.5. Product improvements**

Due to constant product improvement, product specifications may change from time to time. As a standard reporting procedure of the Product Change Notification (PCN) according to the JEDEC-Standard, we inform about major changes. In case of further queries regarding the PCN, the field sales engineer, the internal sales person or the technical support team in charge should be contacted. The basic responsibility of the customer as per section 23.1 and 23.2 remains unaffected. All wireless connectivity module driver software "wireless connectivity SDK" and its source codes as well as all PC software tools are not subject to the Product Change Notification information process.

## **23.6. Product life cycle**

Due to technical progress and economical evaluation we also reserve the right to discontinue production and delivery of products. As a standard reporting procedure of the Product Termination Notification (PTN) according to the JEDEC-Standard we will inform at an early stage about inevitable product discontinuance. According to this, we cannot ensure that all products within our product range will always be available. Therefore, it needs to be verified with the field sales engineer or the internal sales person in charge about the current product availability expectancy before or when the product for application design-in disposal is considered. The approach named above does not apply in the case of individual agreements deviating from the foregoing for customer-specific products.

## **23.7. Property rights**

All the rights for contractual products produced by Würth Elektronik eiSos GmbH & Co. KG on the basis of ideas, development contracts as well as models or templates that are subject to copyright, patent or commercial protection supplied to the customer will remain with Würth Elektronik eiSos GmbH & Co. KG. Würth Elektronik eiSos GmbH & Co. KG does not warrant or represent that any license, either expressed or implied, is granted under any patent right, copyright, mask work right, or other intellectual property right relating to any combination, application, or process in which Würth Elektronik eiSos GmbH & Co. KG components or services are used.

## **23.8. General terms and conditions**

Unless otherwise agreed in individual contracts, all orders are subject to the current version of the "General Terms and Conditions of Würth Elektronik eiSos Group", last version available at [www.we-online.com](http://www.we-online.com).

## **24. Legal notice**

### **24.1. Exclusion of liability**

Würth Elektronik eiSos GmbH & Co. KG considers the information in this document to be correct at the time of publication. However, Würth Elektronik eiSos GmbH & Co. KG reserves the right to modify the information such as technical specifications or functions of its products or discontinue the production of these products or the support of one of these products without any written announcement or notification to customers. The customer must make sure that the information used corresponds to the latest published information. Würth Elektronik eiSos GmbH & Co. KG does not assume any liability for the use of its products. Würth Elektronik eiSos GmbH & Co. KG does not grant licenses for its patent rights or for any other of its intellectual property rights or third-party rights.

Notwithstanding anything above, Würth Elektronik eiSos GmbH & Co. KG makes no representations and/or warranties of any kind for the provided information related to their accuracy, correctness, completeness, usage of the products and/or usability for customer applications. Information published by Würth Elektronik eiSos GmbH & Co. KG regarding third-party products or services does not constitute a license to use such products or services or a warranty or endorsement thereof.

### **24.2. Suitability in customer applications**

The customer bears the responsibility for compliance of systems or units, in which Würth Elektronik eiSos GmbH & Co. KG products are integrated, with applicable legal regulations. Customer acknowledges and agrees that it is solely responsible for compliance with all legal, regulatory and safety-related requirements concerning its products, and any use of Würth Elektronik eiSos GmbH & Co. KG components in its applications, notwithstanding any applications-related information or support that may be provided by Würth Elektronik eiSos GmbH & Co. KG. Customer represents and agrees that it has all the necessary expertise to create and implement safeguards which anticipate dangerous consequences of failures, monitor failures and their consequences lessen the likelihood of failures that might cause harm and take appropriate remedial actions. The customer will fully indemnify Würth Elektronik eiSos GmbH & Co. KG and its representatives against any damages arising out of the use of any Würth Elektronik eiSos GmbH & Co. KG components in safety-critical applications.

### **24.3. Trademarks**

AMBER wireless is a registered trademark of Würth Elektronik eiSos GmbH & Co. KG. All other trademarks, registered trademarks, and product names are the exclusive property of the respective owners.

### **24.4. Usage restriction**

Würth Elektronik eiSos GmbH & Co. KG products have been designed and developed for usage in general electronic equipment only. This product is not authorized for use in equipment

where a higher safety standard and reliability standard is especially required or where a failure of the product is reasonably expected to cause severe personal injury or death, unless the parties have executed an agreement specifically governing such use. Moreover, Würth Elektronik eiSos GmbH & Co. KG products are neither designed nor intended for use in areas such as military, aerospace, aviation, nuclear control, submarine, transportation (automotive control, train control, ship control), transportation signal, disaster prevention, medical, public information network etc. Würth Elektronik eiSos GmbH & Co. KG must be informed about the intent of such usage before the design-in stage. In addition, sufficient reliability evaluation checks for safety must be performed on every electronic component, which is used in electrical circuits that require high safety and reliability function or performance. By using Würth Elektronik eiSos GmbH & Co. KG products, the customer agrees to these terms and conditions.

## 25. License terms

These License terms will take effect upon the purchase and usage of the Würth Elektronik eiSos GmbH & Co. KG wireless connectivity products. You hereby agree that these license terms are applicable to the product and the incorporated software, firmware and source codes (collectively, "Software") made available by Würth Elektronik eiSos in any form, including but not limited to binary, executable or source code form.

The software included in any Würth Elektronik eiSos wireless connectivity product is purchased to you on the condition that you accept the terms and conditions of these license terms. You agree to comply with all provisions under these license terms.

### 25.1. Limited license

Würth Elektronik eiSos hereby grants you a limited, non-exclusive, non-transferable and royalty-free license to use the software and under the conditions that will be set forth in these license terms. You are free to use the provided software only in connection with one of the products from Würth Elektronik eiSos to the extent described in these license terms. You are entitled to change or alter the source code for the sole purpose of creating an application embedding the Würth Elektronik eiSos wireless connectivity product. The transfer of the source code to third parties is allowed to the sole extent that the source code is used by such third parties in connection with our product or another hardware provided by Würth Elektronik eiSos under strict adherence of these license terms. Würth Elektronik eiSos will not assume any liability for the usage of the incorporated software and the source code. You are not entitled to transfer the source code in any form to third parties without prior written consent of Würth Elektronik eiSos.

You are not allowed to reproduce, translate, reverse engineer, decompile, disassemble or create derivative works of the incorporated software and the source code in whole or in part. No more extensive rights to use and exploit the products are granted to you.

### 25.2. Usage and obligations

The responsibility for the applicability and use of the Würth Elektronik eiSos wireless connectivity product with the incorporated firmware in a particular customer design is always solely within the authority of the customer. Due to this fact, it is up to you to evaluate and investigate, where appropriate, and to decide whether the device with the specific product characteristics described in the product specification is valid and suitable for your respective application or not.

You are responsible for using the Würth Elektronik eiSos wireless connectivity product with the incorporated firmware in compliance with all applicable product liability and product safety laws. You acknowledge to minimize the risk of loss and harm to individuals and bear the risk for failure leading to personal injury or death due to your usage of the product.

Würth Elektronik eiSos' products with the incorporated firmware are not authorized for use in safety-critical applications, or where a failure of the product is reasonably expected to cause severe personal injury or death. Moreover, Würth Elektronik eiSos' products with the incorporated firmware are neither designed nor intended for use in areas such as military, aerospace, aviation, nuclear control, submarine, transportation (automotive control, train control, ship control), transportation signal, disaster prevention, medical, public information network etc. You



shall inform Würth Elektronik eiSos about the intent of such usage before design-in stage. In certain customer applications requiring a very high level of safety and in which the malfunction or failure of an electronic component could endanger human life or health, you must ensure to have all necessary expertise in the safety and regulatory ramifications of your applications. You acknowledge and agree that you are solely responsible for all legal, regulatory and safety-related requirements concerning your products and any use of Würth Elektronik eiSos' products with the incorporated firmware in such safety-critical applications, notwithstanding any applications-related information or support that may be provided by Würth Elektronik eiSos. YOU SHALL INDEMNIFY WÜRTH ELEKTRONIK EISOS AGAINST ANY DAMAGES ARISING OUT OF THE USE OF WÜRTH ELEKTRONIK EISOS' PRODUCTS WITH THE INCORPORATED FIRMWARE IN SUCH SAFETY-CRITICAL APPLICATIONS.

### **25.3. Ownership**

The incorporated firmware created by Würth Elektronik eiSos is and will remain the exclusive property of Würth Elektronik eiSos.

### **25.4. Firmware update(s)**

You have the opportunity to request the current and actual firmware for a bought wireless connectivity product within the time of warranty. However, Würth Elektronik eiSos has no obligation to update a modules firmware in their production facilities, but can offer this as a service on request. The upload of firmware updates falls within your responsibility, e.g. via ACC or another software for firmware updates. Firmware updates will not be communicated automatically. It is within your responsibility to check the current version of a firmware in the latest version of the product manual on our website. The revision table in the product manual provides all necessary information about firmware updates. There is no right to be provided with binary files, so called "firmware images", those could be flashed through JTAG, SWD, Spi-Bi-Wire, SPI or similar interfaces.

### **25.5. Disclaimer of warranty**

THE FIRMWARE IS PROVIDED "AS IS". YOU ACKNOWLEDGE THAT WÜRTH ELEKTRONIK EISOS MAKES NO REPRESENTATIONS AND WARRANTIES OF ANY KIND RELATED TO, BUT NOT LIMITED TO THE NON-INFRINGEMENT OF THIRD PARTIES' INTELLECTUAL PROPERTY RIGHTS OR THE MERCHANTABILITY OR FITNESS FOR YOUR INTENDED PURPOSE OR USAGE. WÜRTH ELEKTRONIK EISOS DOES NOT WARRANT OR REPRESENT THAT ANY LICENSE, EITHER EXPRESS OR IMPLIED, IS GRANTED UNDER ANY PATENT RIGHT, COPYRIGHT, MASK WORK RIGHT, OR OTHER INTELLECTUAL PROPERTY RIGHT RELATING TO ANY COMBINATION, MACHINE, OR PROCESS IN WHICH THE WÜRTH ELEKTRONIK EISOS' PRODUCT WITH THE INCORPORATED FIRMWARE IS USED. INFORMATION PUBLISHED BY WÜRTH ELEKTRONIK EISOS REGARDING THIRD-PARTY PRODUCTS OR SERVICES DOES NOT CONSTITUTE A LICENSE FROM WÜRTH ELEKTRONIK EISOS TO USE SUCH PRODUCTS OR SERVICES OR A WARRANTY OR ENDORSEMENT THEREOF.



## **25.6. Limitation of liability**

Any liability not expressly provided by Würth Elektronik eiSos shall be disclaimed. You agree to hold us harmless from any third-party claims related to your usage of the Würth Elektronik eiSos' products with the incorporated firmware, software and source code. Würth Elektronik eiSos disclaims any liability for any alteration, development created by you or your customers as well as for any combination with other products.

## **25.7. Applicable law and jurisdiction**

Applicable law to these license terms shall be the laws of the Federal Republic of Germany. Any dispute, claim or controversy arising out of or relating to these license terms shall be resolved and finally settled by the court competent for the location of Würth Elektronik eiSos registered office.

## **25.8. Severability clause**

If a provision of these license terms is or becomes invalid, unenforceable or null and void, this shall not affect the remaining provisions of the terms. The parties shall replace any such provisions with new valid provisions that most closely approximate the purpose of the terms.

## **25.9. Miscellaneous**

Würth Elektronik eiSos reserves the right at any time to change this terms at its own discretion. It is your responsibility to check at Würth Elektronik eiSos homepage for any updates. Your continued usage of the products will be deemed as the acceptance of the change.

We recommend you to be updated about the status of new firmware and software, which is available on our website or in our data sheet and manual, and to implement new software in your device where appropriate.

By ordering a product, you accept these license terms in all terms.

## List of Figures

1.	Block diagram . . . . .	12
2.	Pinout . . . . .	17
3.	Power up . . . . .	19
4.	Range extension using repeaters . . . . .	92
5.	Example network . . . . .	95
6.	Layout . . . . .	103
7.	Placement of the module with integrated antenna . . . . .	104
8.	Dimensioning the antenna feed line as micro strip . . . . .	105
9.	868 MHz dipole-antenna . . . . .	107
10.	915 MHz dipole-antenna . . . . .	108
11.	Assembly diagram . . . . .	112
12.	Top and Bottom Layer . . . . .	112
13.	Reflow soldering profile . . . . .	114
14.	Module dimensions [mm] . . . . .	119
15.	Footprint and dimensions [mm] . . . . .	120
16.	Lot number structure . . . . .	121
17.	Label of the Telesto-I . . . . .	122
18.	FCC certificate . . . . .	125
19.	IC certificate . . . . .	126

## List of Tables

1.	Ordering information . . . . .	13
2.	Recommended operating conditions . . . . .	14
3.	Absolute maximum ratings . . . . .	14
4.	Power consumption . . . . .	15
5.	Radio characteristics . . . . .	15
6.	Pin characteristics . . . . .	16
7.	Pinout . . . . .	18
8.	Communication in transparent mode . . . . .	24
9.	Telegram format in the command mode . . . . .	27
10.	Message overview . . . . .	29
11.	Overview of non-volatile user-settings . . . . .	49
12.	Configuration flags . . . . .	71
13.	Repeater configuration flags . . . . .	73
14.	Common settings of RP_NumSlots . . . . .	75
15.	radio profiles . . . . .	83
16.	Overview of the channels with remark relating to compliance, 50 Ω conducted. . . . .	91
17.	Classification reflow soldering profile, Note: refer to IPC/JEDEC J-STD-020E . . . . .	113
18.	Package classification reflow temperature, PB-free assembly, Note: refer to IPC/- JEDEC J-STD-020E . . . . .	114
19.	Dimensions . . . . .	118
20.	Weight . . . . .	118
21.	Lot number details . . . . .	121
22.	CRC8 Test Vectors . . . . .	137

## A. Additional CRC8 Information

This Annex gives an example CRC8 implementation and test vectors.

### A.1. Example CRC8 Implementation

```
#include <stdint.h>

uint8_t Get_CRC8(uint8_t * bufP, uint16_t len)
{
    uint8_t crc = 0x00;
    for (uint16_t i = 0; i < len; i++)
    {
        crc ^= bufP[i];
    }
    return crc;
}
```

Code 1: Example CRC8 Implementation

### A.2. CRC8 Test Vectors

Input data	Data length	Resulting CRC8
Null	0	0x00
0x02 0x01 0x00 0x00	4	0x03
0x02 0x87 0x01 0x00 0x16	5	0x92
0x02 0x04 0x04 0x00 0x41 0x42 0x43 0x44	8	0x06
0x02 0x88 0x07 0x00 0x00 0x55 0x00 0x00 0xDA 0x18 0x00	11	0x1A

Table 22: CRC8 Test Vectors

## B. Example codes for host integration

The following code is an example implementation of a function to transmit data using a 1 Byte length field in the command frame. For demonstration reasons the Tarvos-III has been taken. The full function codes of all radio modules are available in the Wireless Connectivity SDK ([www.we-online.de/wco-SDK](http://www.we-online.de/wco-SDK)).

```
#define CMD_PAYLOAD_MAX 224
typedef struct {
uint8_t Stx;
uint8_t Cmd;
uint8_t Length;
uint8_t Data[CMD_PAYLOAD_MAX+1]; /* +1 for CRC8 */
} CMD_Frame_t;
#define CMD_OFFSET_TO_DATAFIELD 3
#define CMD_OVERHEAD (CMD_OFFSET_TO_DATAFIELD+1)

bool TarvosIII_Transmit(uint8_t *PayloadP, uint8_t length)
{
/* fill request message with STX, command byte and length field */
CMD_Frame_t CMD_Frame;
CMD_Frame.Stx = CMD_STX; /* 0x02 */
CMD_Frame.Cmd = TarvosIII_CMD_DATA_REQ; /* 0x00 */
CMD_Frame.Length = length;

/* fill request message with user payload */
memcpy(CMD_Frame.Data, PayloadP, length);

/* fill request message with CRC8 */
CMD_Frame.Data[CMD_Frame.Length] = Get_CRC8(&CMD_Frame, CMD_Frame.Length +
    CMD_OFFSET_TO_DATAFIELD);

/* transmit full message via UART to radio module */
UART_SendBytes(&CMD_Frame, (CMD_Frame.Length + CMD_OVERHEAD));

/* wait for response message from radio module */
return UART_Wait_for_Response(CMD_WAIT_TIME, TarvosIII_CMD_DATA_CNF, CMD_Status_Success, true)
;
}

```

Code 2: Example function implementation for radio modules with 1 byte length field



**Contact**

Würth Elektronik eiSos GmbH & Co. KG  
Division Wireless Connectivity & Sensors

Max-Eyth-Straße 1  
74638 Waldenburg  
Germany

Tel.: +49 651 99355-0  
Fax.: +49 651 99355-69  
[www.we-online.com/wireless-connectivity](http://www.we-online.com/wireless-connectivity)

**WÜRTH ELEKTRONIK** MORE THAN YOU EXPECT